

Microensing IV: Microlens Parallax: Ground and Space

Andy Gould (Ohio State)

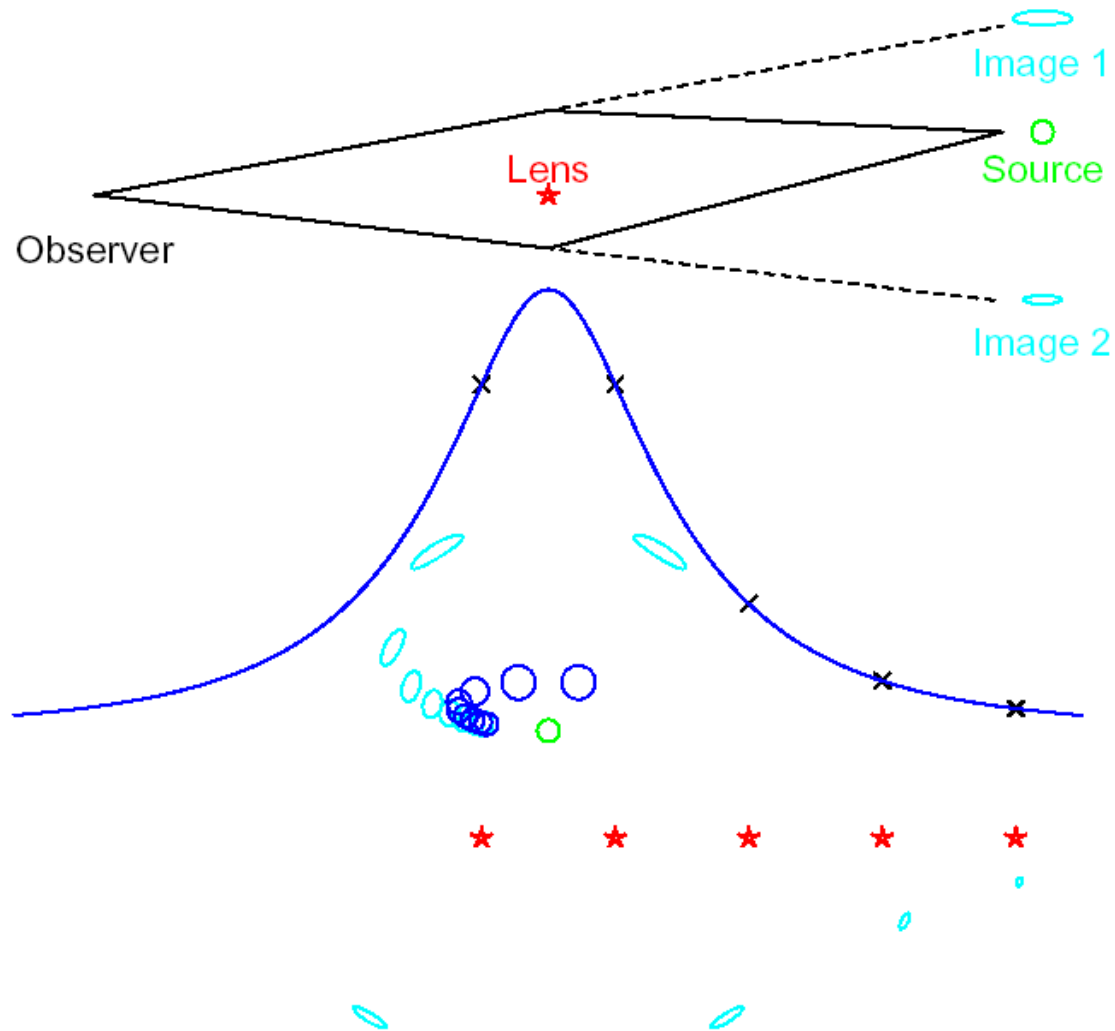

Mao & Paczynski

Central Caustics

GRAVITATIONAL MICROLENSING BY DOUBLE STARS AND PLANETARY SYSTEMS

SHUDE MAO AND BOHDAN PACZYŃSKI

Princeton University Observatory, Princeton, NJ 08544

Received 1991 March 12; accepted 1991 April 2

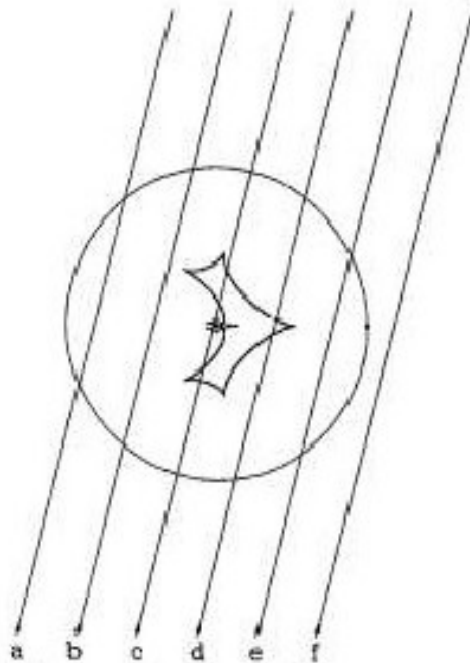

1.—Geometry of microlensing by a binary, as seen in the sky. The primary star of $1 M_{\odot}$ is located at the center of the figure, and the secondary of $1 M_{\odot}$ or $0.001 M_{\odot}$ is located on the right, on the Einstein ring of the primary. The radius of the ring is 1.0 mas for a source located at a distance of 8 kpc. The two complicated shapes around the primary are

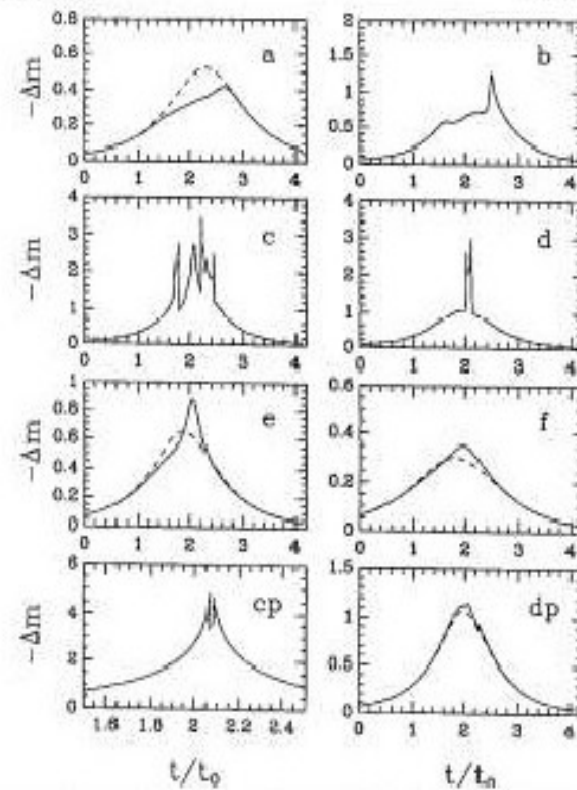

the lens. The effect is strong even if the companion is a planet. A massive search for microlensing of the Galactic bulge stars may lead to a discovery of the first extrasolar planetary systems.

Gould & Loeb

Planetary Caustics

DISCOVERING PLANETARY SYSTEMS THROUGH GRAVITATIONAL MICROLENSSES

ANDREW GOULD AND ABRAHAM LOEB
Institute for Advanced Study, Princeton, NJ 08540
Received 1991 December 26; accepted 1992 March 9

5. OBSERVATIONAL REQUIREMENTS

Two distinct steps are required to observe a planetary system by microlensing. First, one must single out a disk star which happens to be microlensing a bulge star. Second, one must observe this star often enough to catch the deviation in the light curve due to the planet. The first step involves the observation of millions of bulge stars on the order of once per day. The second step involves the observation of a handful of stars many times per day. In the following we give a rough outline of what is required for each of these steps.

While observations from one site would be useful, there are advantages to be gained by observing from several sites. First,

two telescopes that were totally committed. Third, in view of the fleeting nature of the events, it would seem prudent to build in some redundancy in case of bad weather at a particular site. Thus, the optimal scheme would employ, say, a dozen telescopes. Each of these would be committed to carry out two observations per night. During the near-December season,

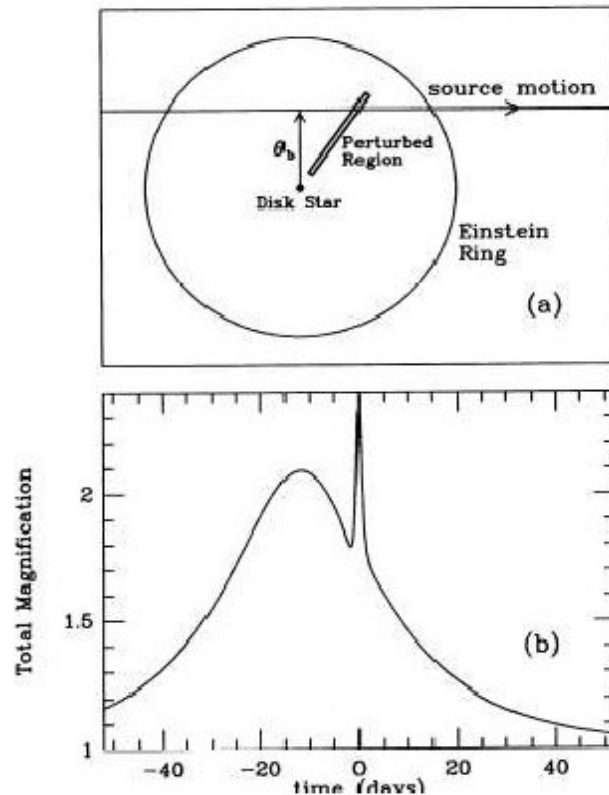

6 Features

& 6 Parameters

Time of Peak

t_0

Height of Peak

u_0

Width of Peak

t_E

Time of Perturbation

Trajectory angle: α

Height of Perturbation

Planet-star separation: s

Width of Perturbation

Planet/star mass ratio: q

6 Features

Time of Peak

Height of Peak

Width of Peak

Time of Perturbation

Height of Perturbation

Width of Perturbation

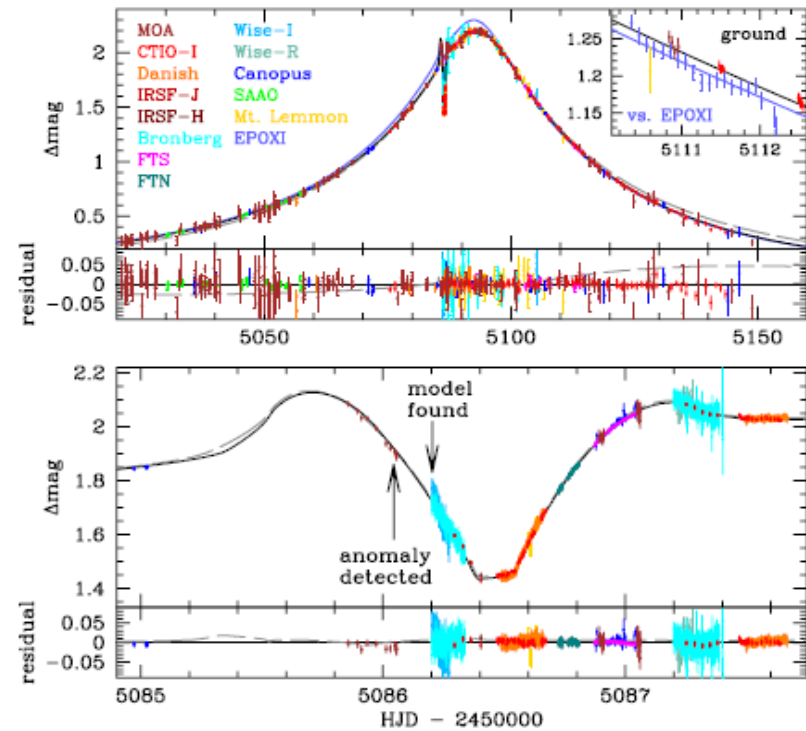

7 Features & 7 Parameters

Time of Peak	t_0
Height of Peak	u_0
Width of Peak	t_E
Time of Perturbation	Trajectory angle: α
Height of Perturbation	Planet-star separation: s
Width of Perturbation	Planet/star mass ratio: q
Width of Caustic Cross	Normalize source size: ρ

7 Features

Time of Peak

Height of Peak

Width of Peak

Time of Perturbation

Height of Perturbation

Width of Perturbation

Width of Caustic Cross

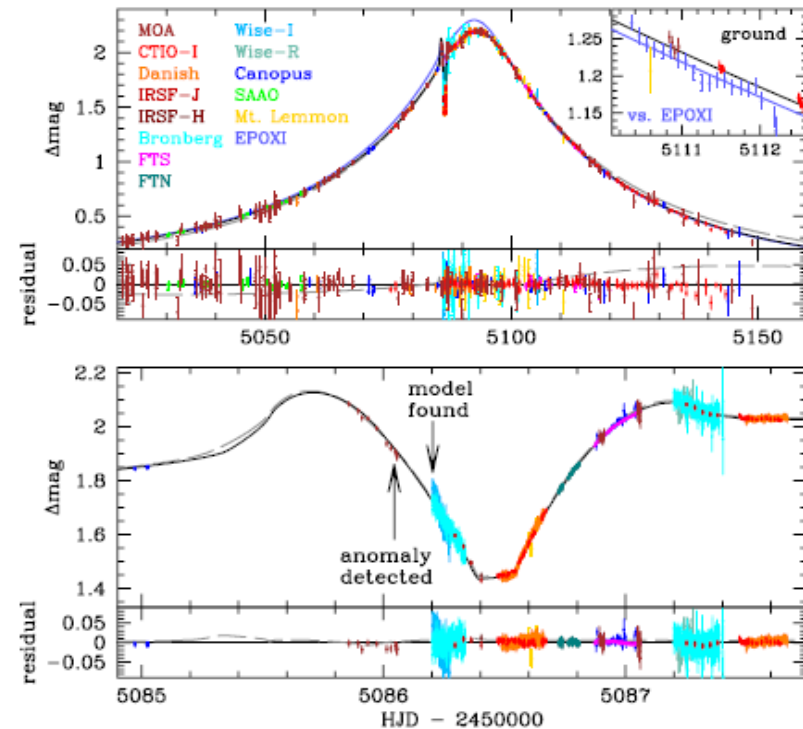
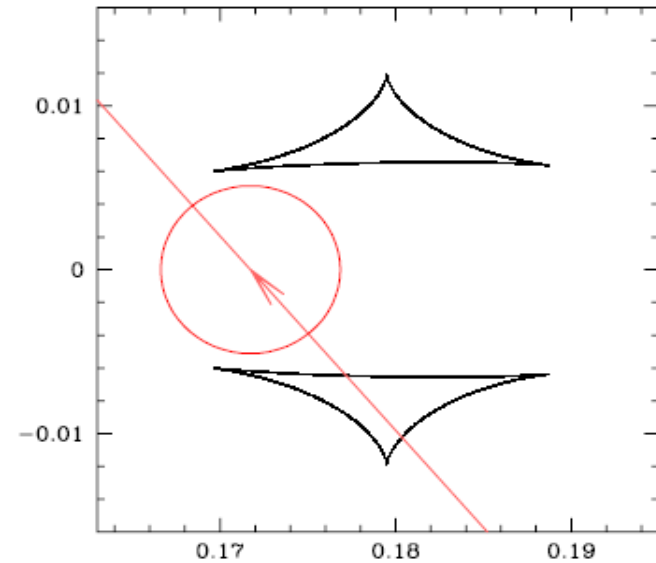

Planets 2011

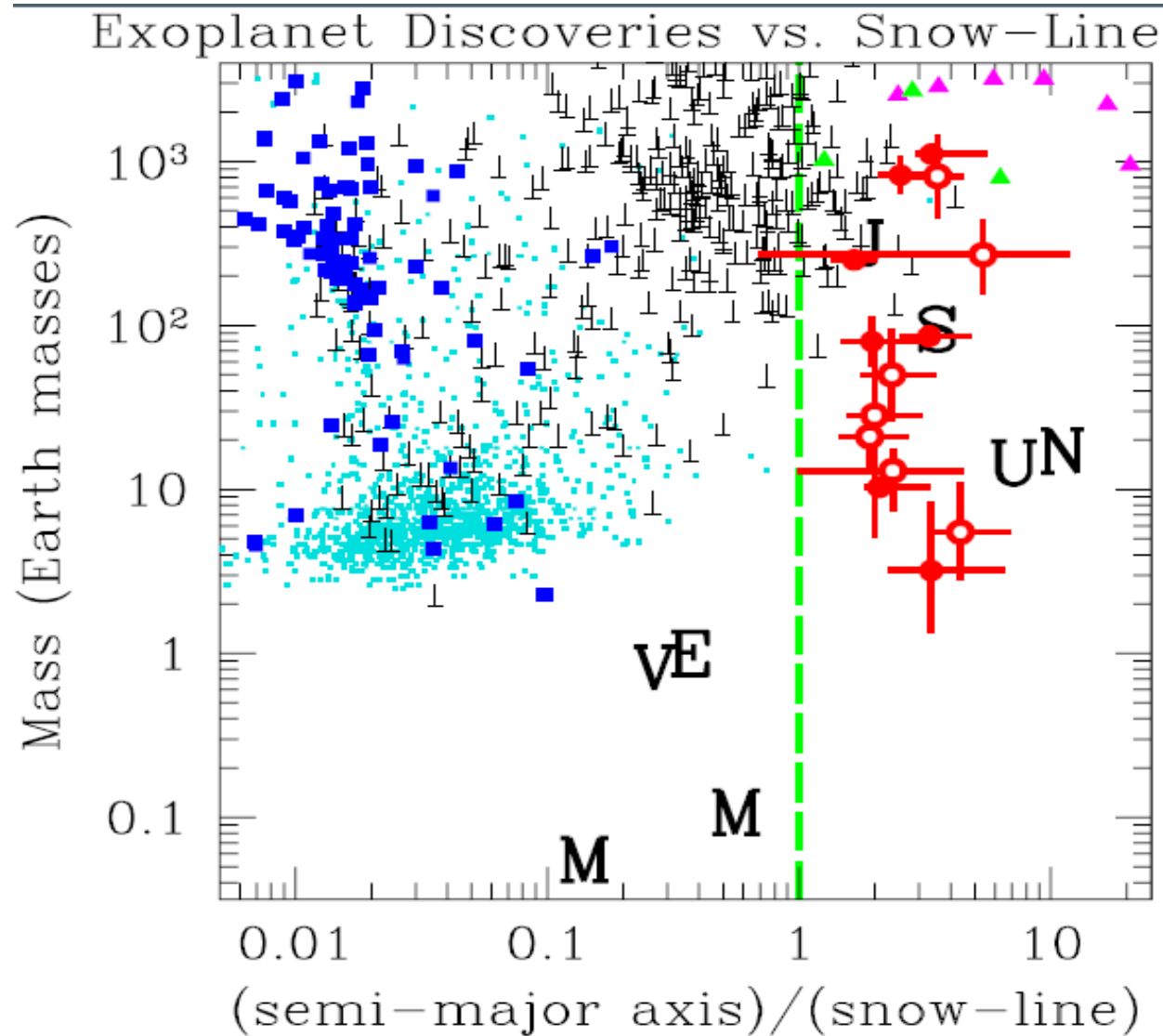

To measure angular Einstein radius: Standard **Sky-Plane** Rulers

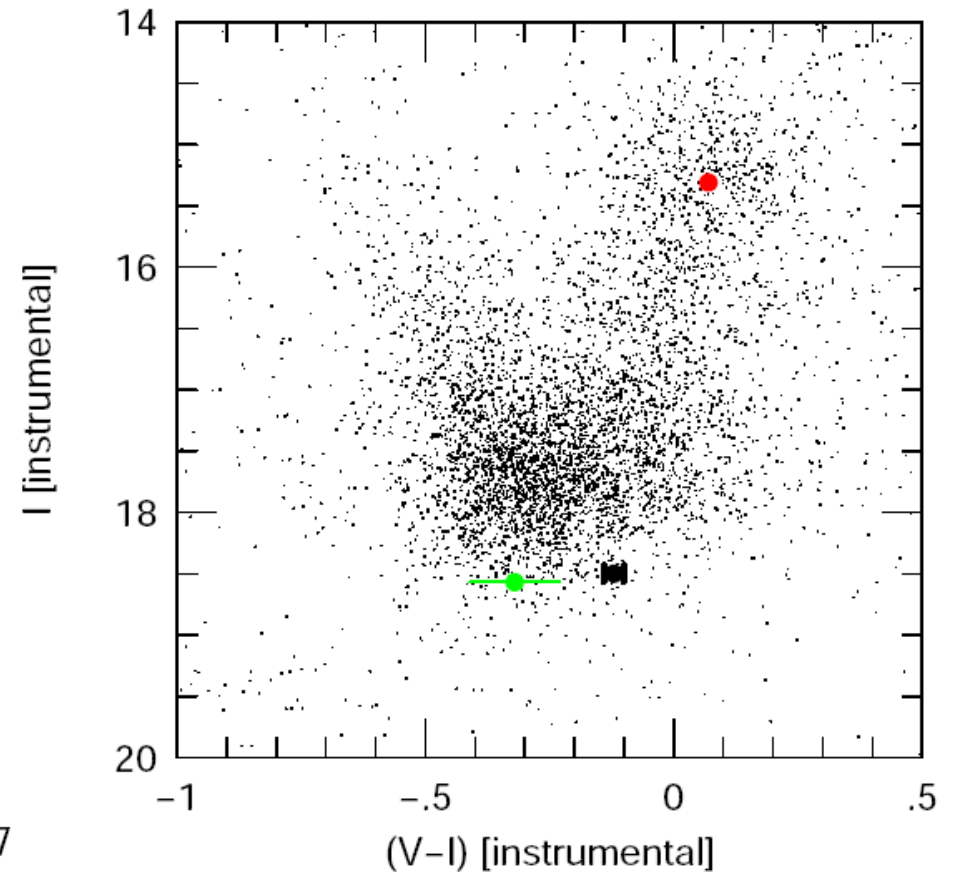
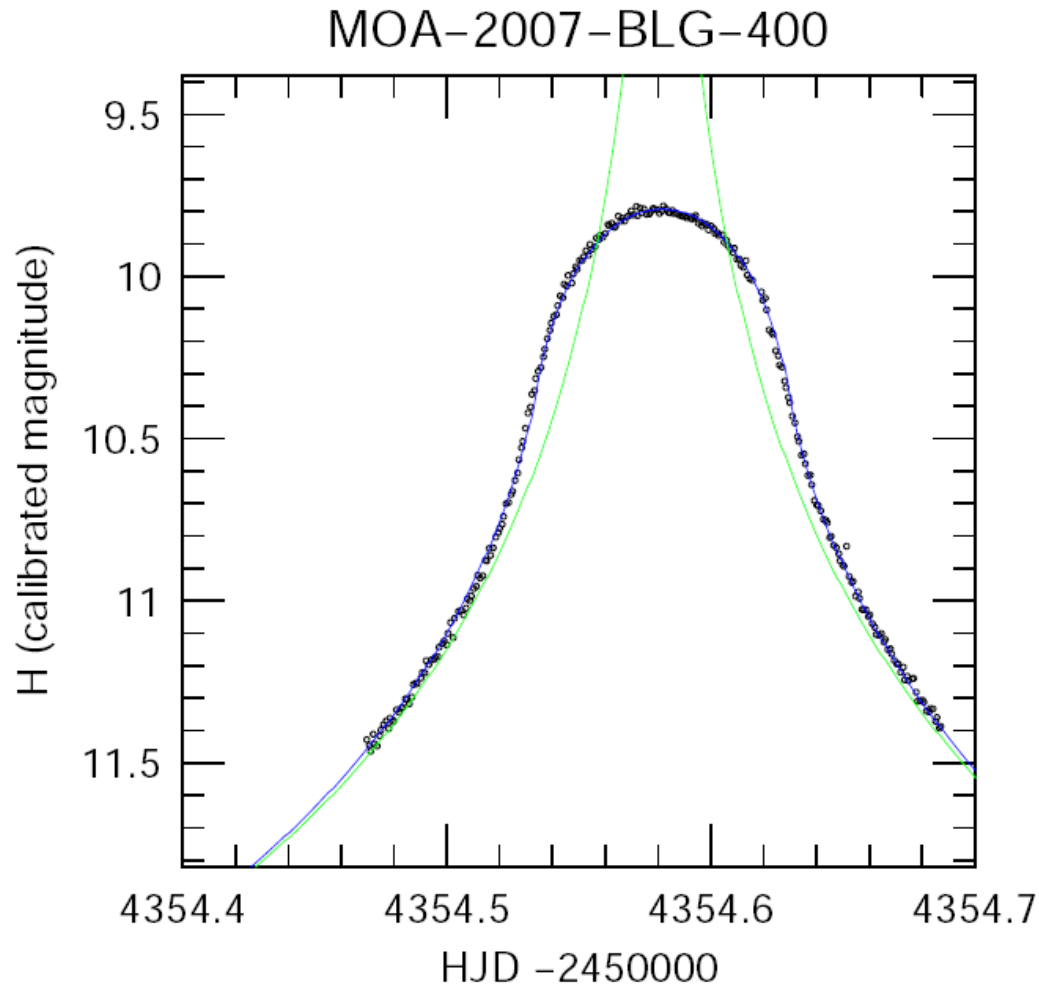

To measure angular Einstein radius: Standard **Sky-Plane** Rulers

$$\rho \equiv \frac{\theta_*}{\theta_E}$$

$$\theta_E = \frac{\theta_*}{\rho}$$

$$f_{s,0} = \pi \theta_*^2 S_0$$

$$\theta_* = \sqrt{\frac{f_s(I_0)}{\pi S[(V - I)_{s,0}]}}$$

$$(V - I)_{s,0} = (V - I)_{clump,0} + \Delta(V - I)$$

$$I_{s,0} = I_{clump,0} + \Delta I$$

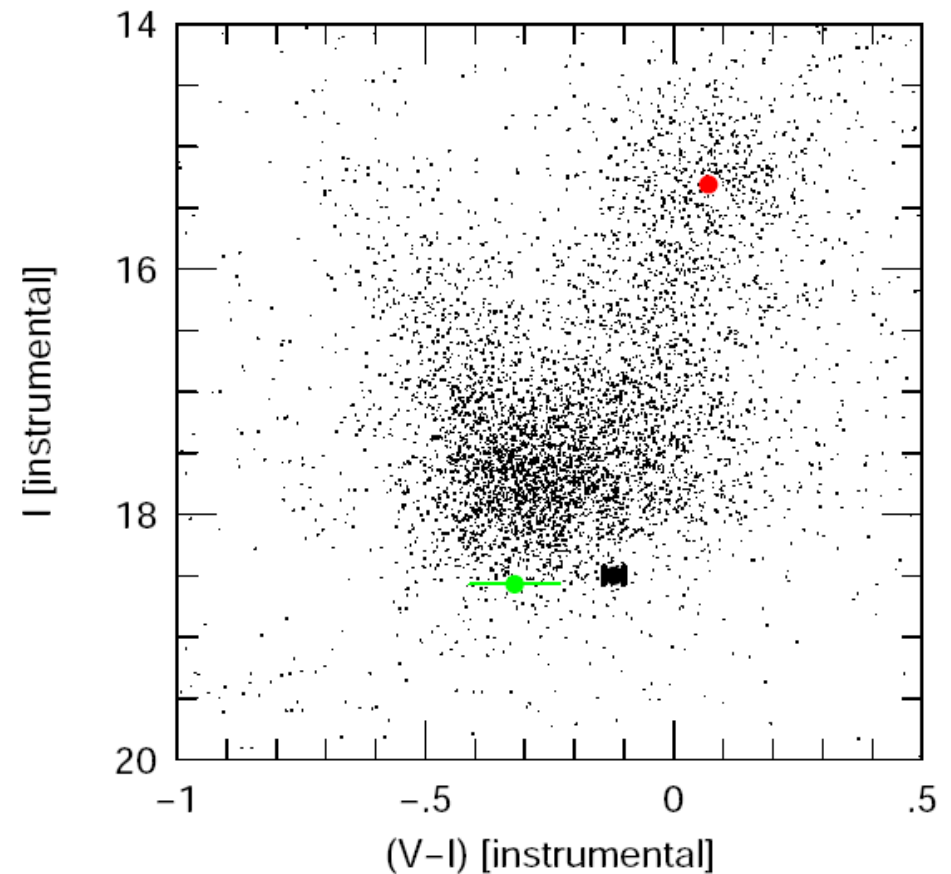

Relation of **Mass** and **Distance** to **Lensing Observables**

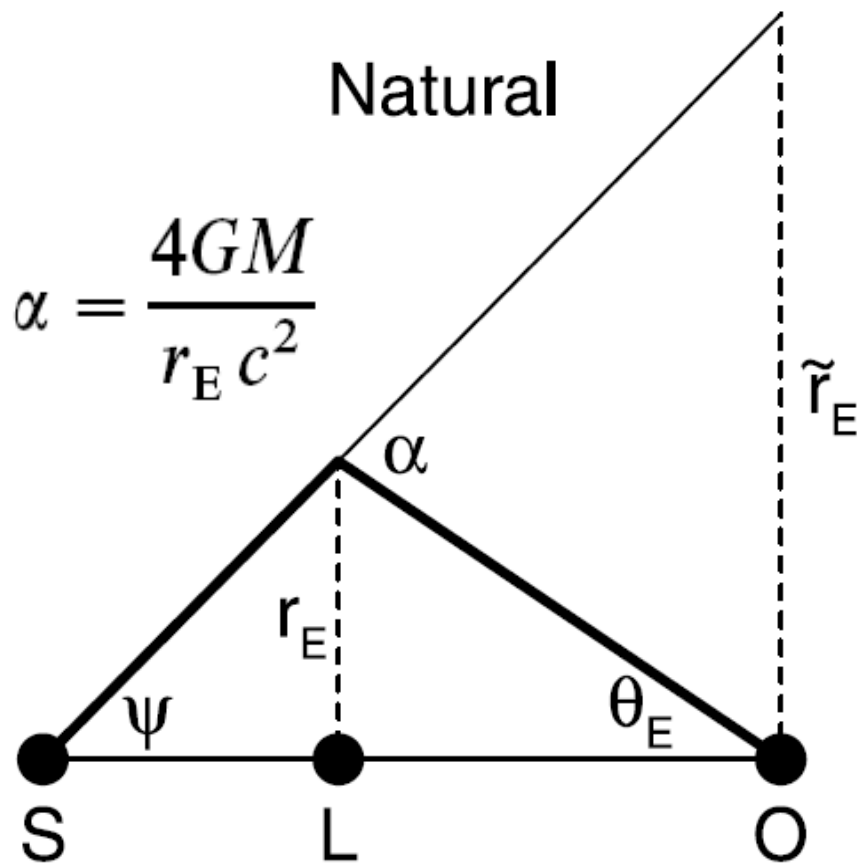

$$\alpha / \tilde{r}_E = \theta_E / r_E$$

$$\theta_E \tilde{r}_E = \alpha r_E = \frac{4GM}{c^2}$$

$$\theta_E = \alpha - \psi = \frac{\tilde{r}_E}{D_l} - \frac{\tilde{r}_E}{D_s} = \frac{\tilde{r}_E}{D_{\text{rel}}}$$

$$\tilde{r}_E = \sqrt{\frac{4GM D_{\text{rel}}}{c^2}} \quad \theta_E = \sqrt{\frac{4GM}{D_{\text{rel}} c^2}}$$

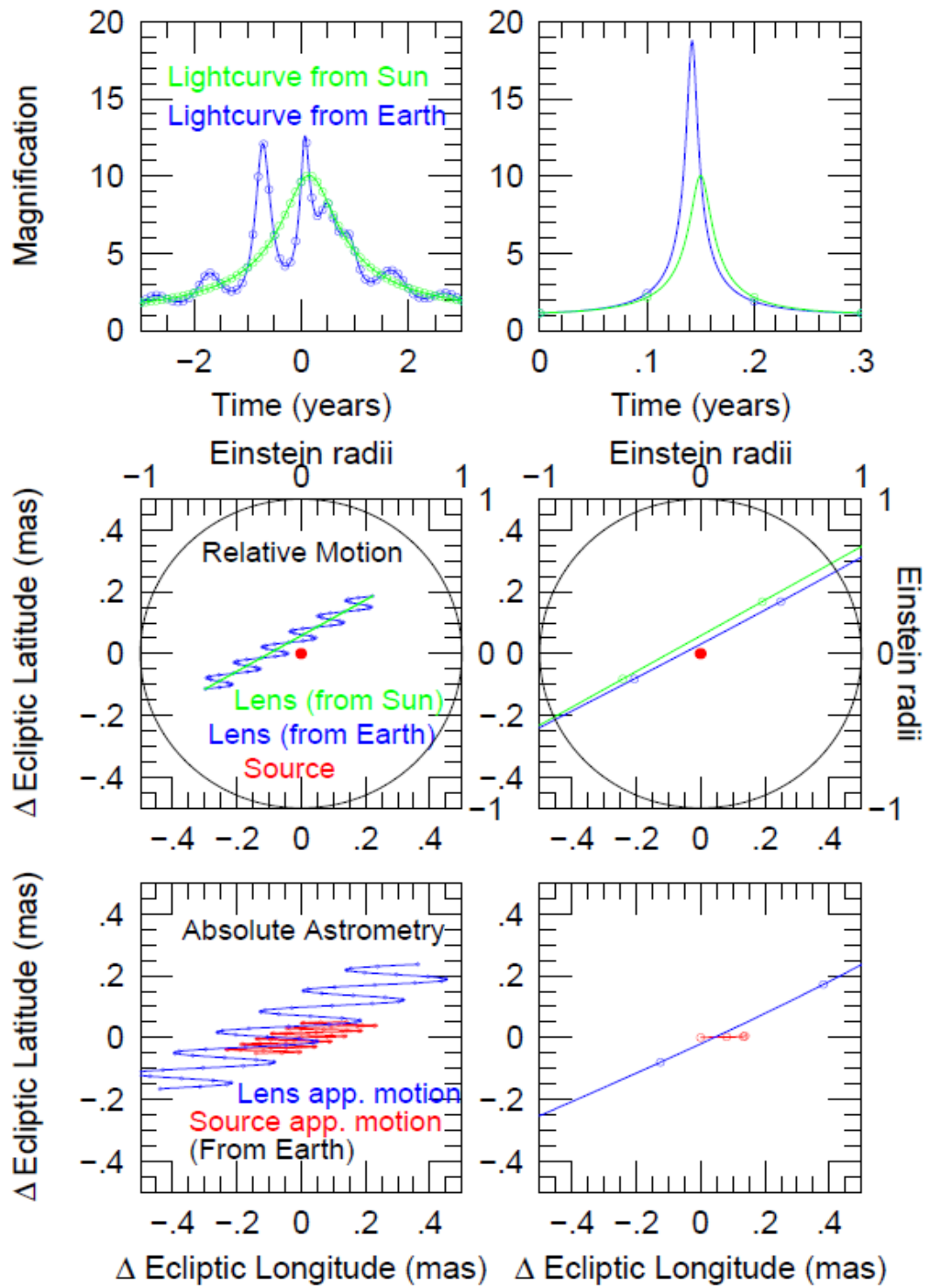

To measure parallax:

Standard Observer-Plane Rulers

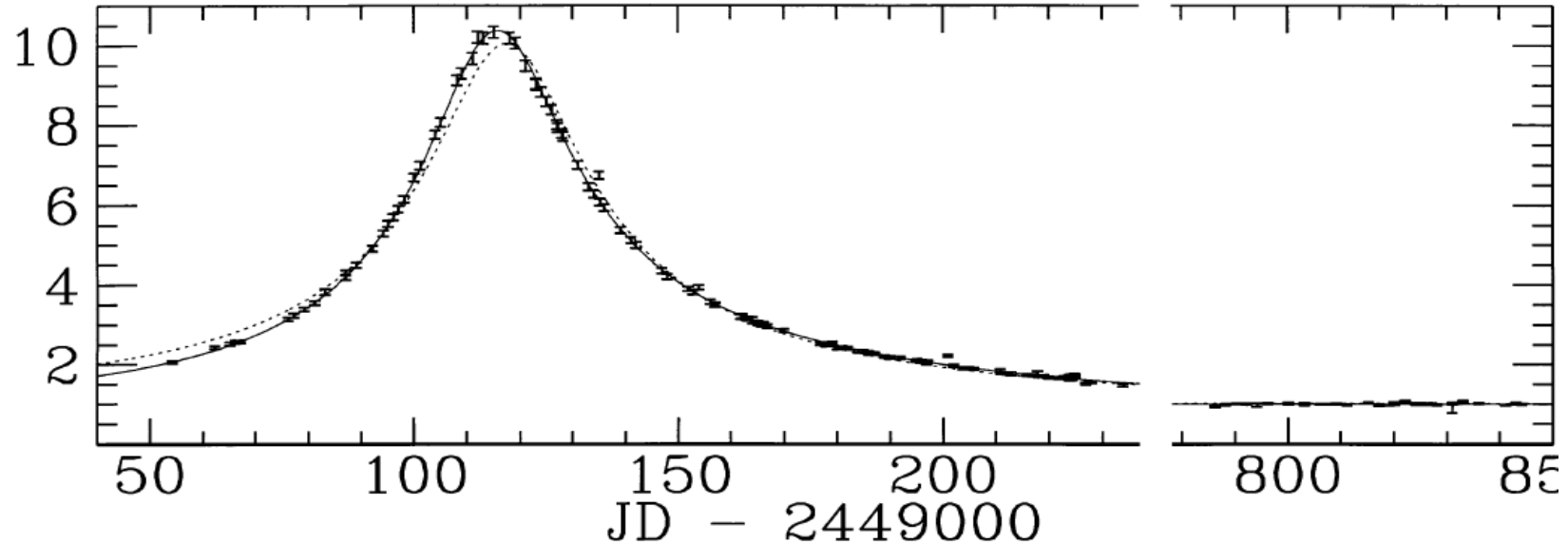
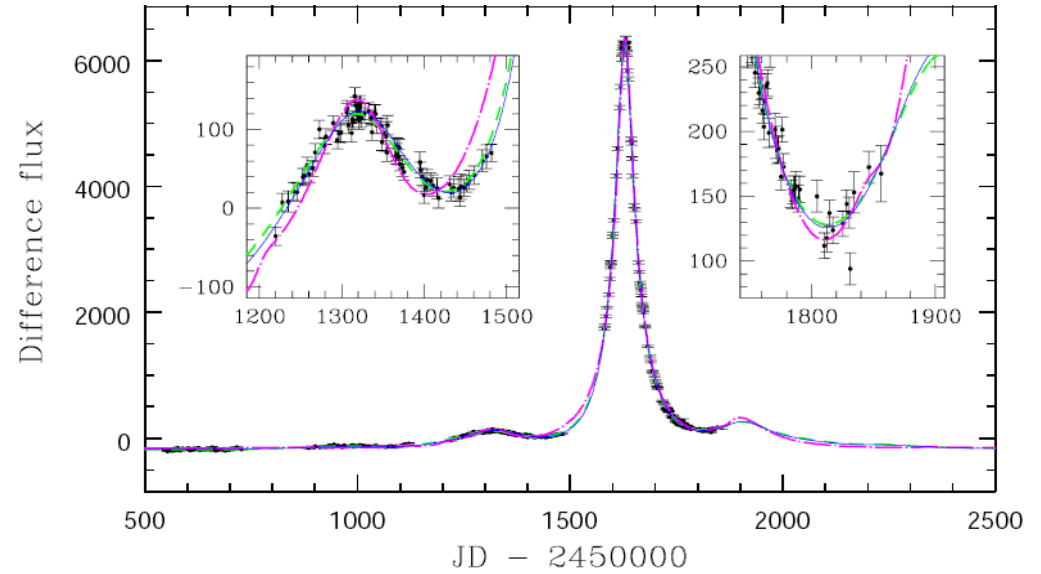
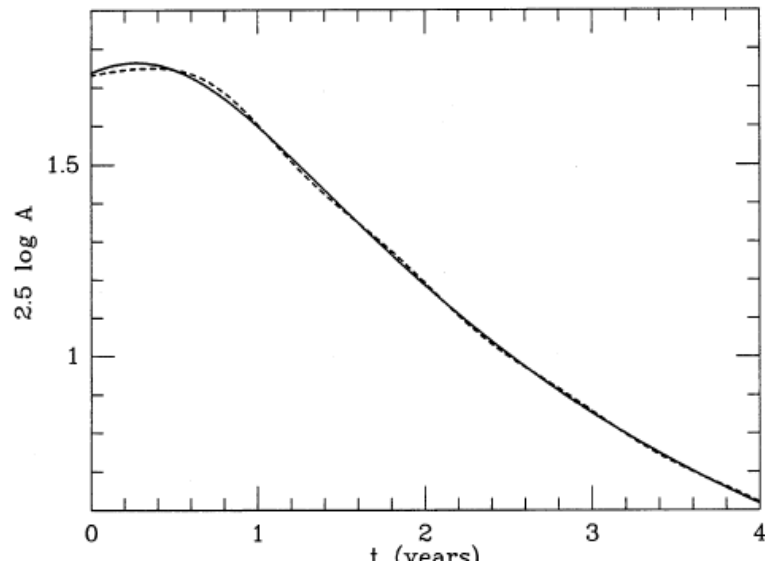

1-D Parallaxes Are “Common”

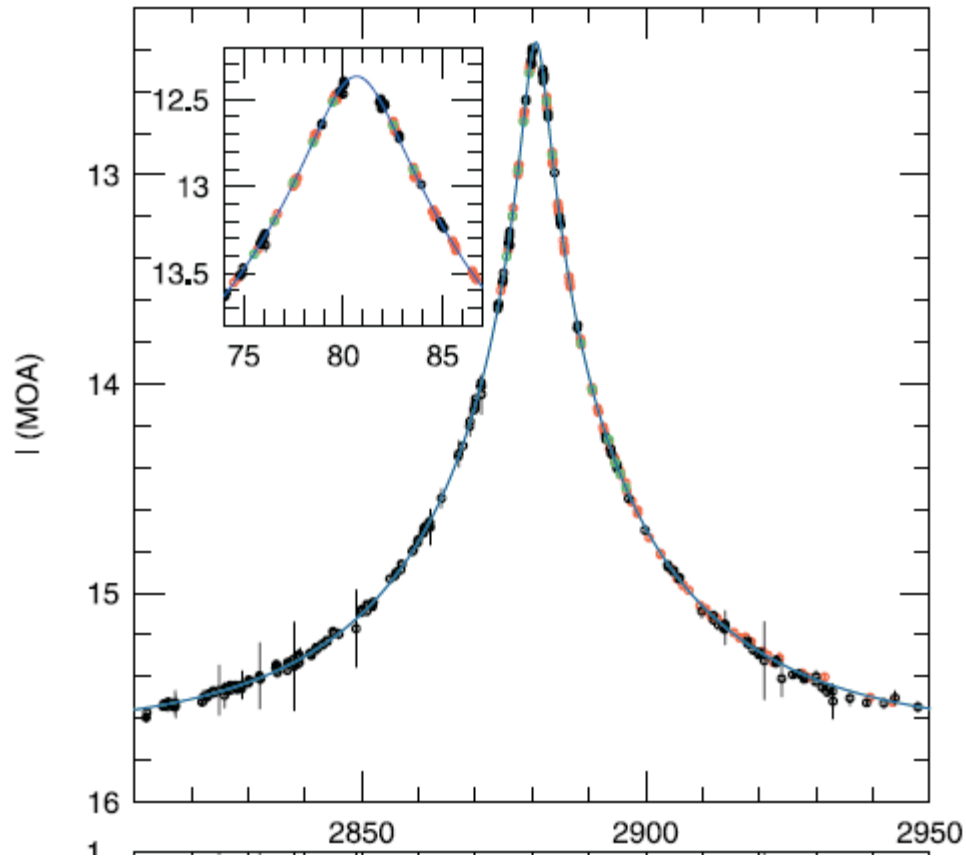

MOA-2003-BLG-37

Park et al. 2004, ApJ. 609, 166

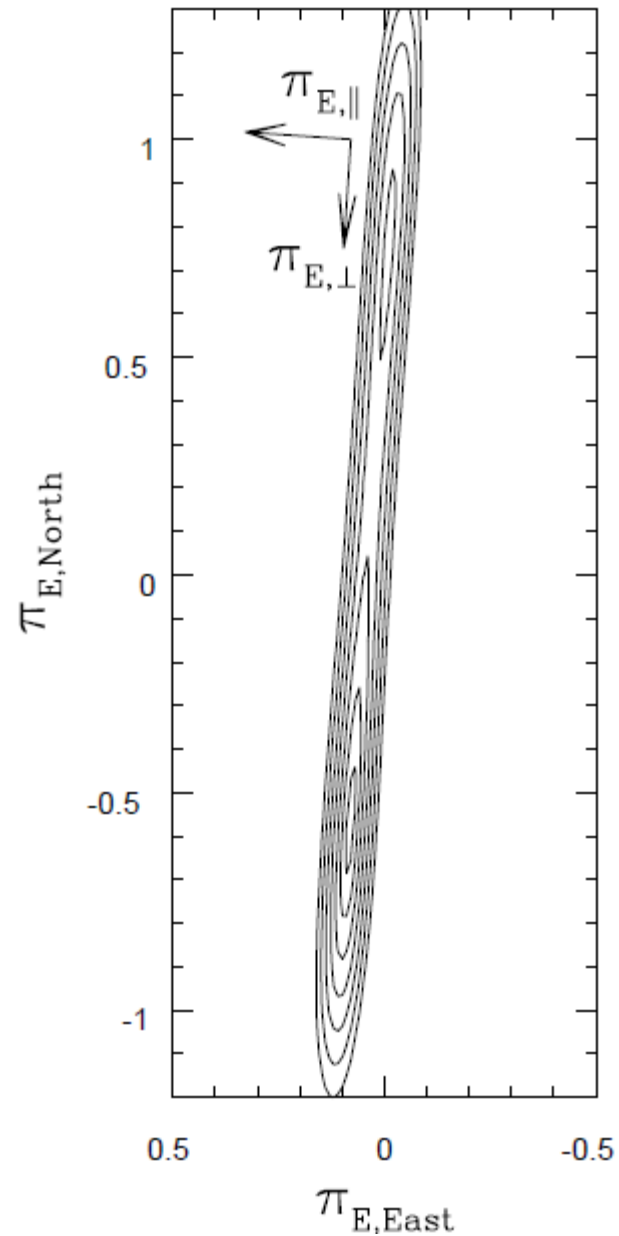

1-D Parallaxes Are “Common”

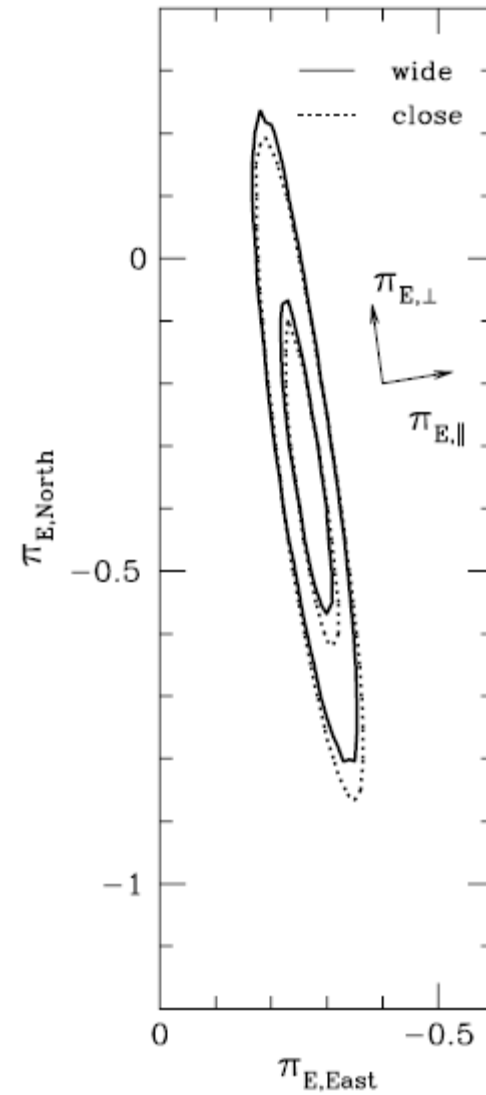
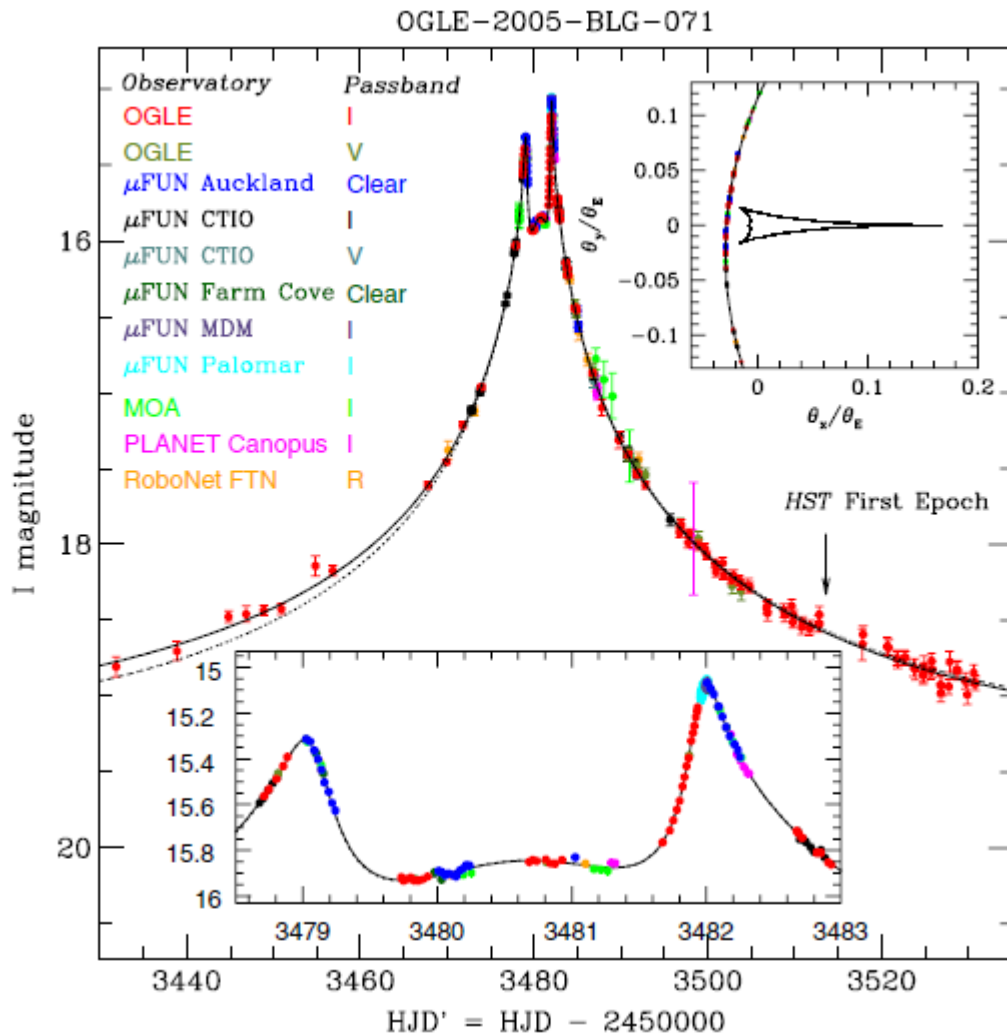

OGLE-2005-BLG-071

Dong et al. 2009, ApJ. 695, 970

1-D Parallaxes Are “Common”

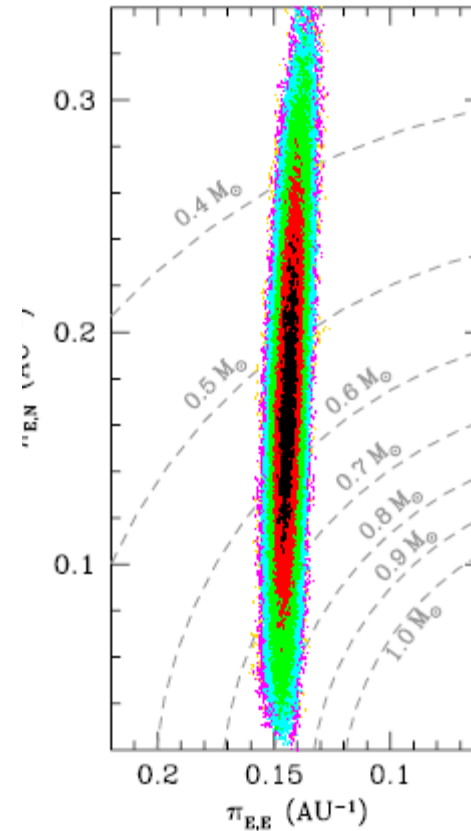
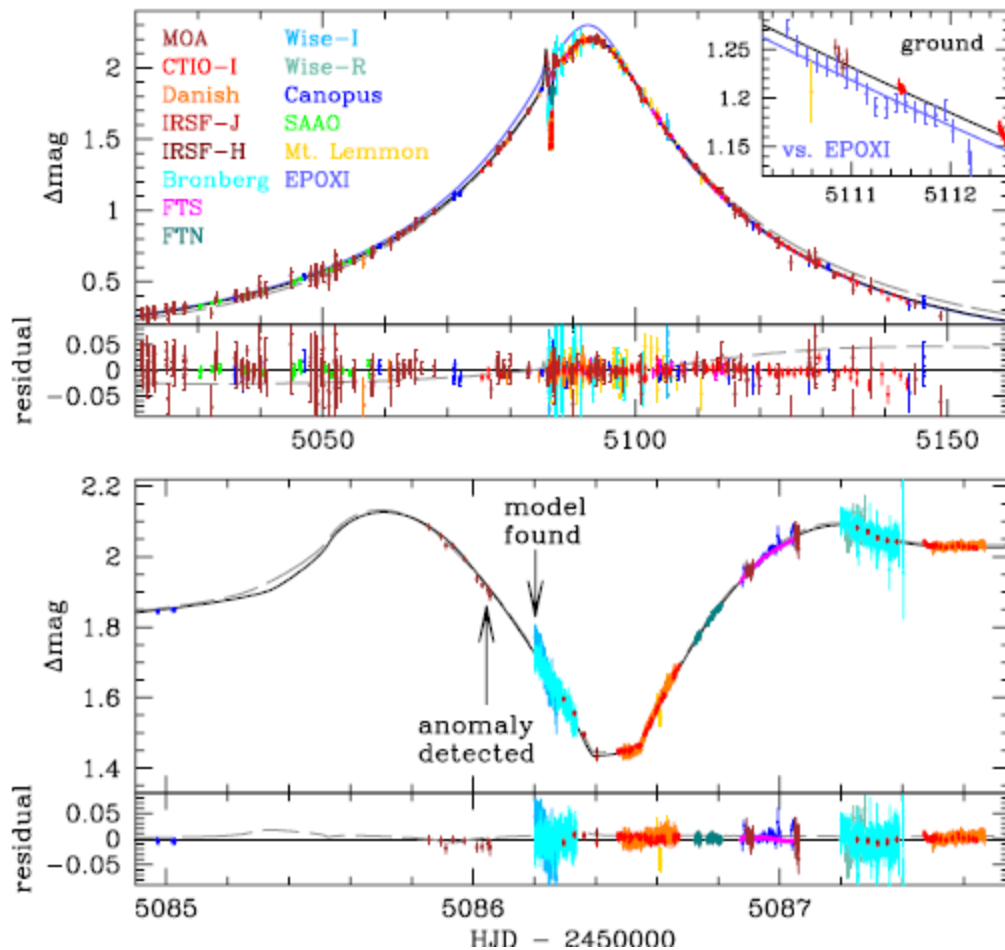

MOA-2009-BLG-266

Muraki et al. 2011, ApJ, 741, 22

$\pi_{E,\text{parallel}}$ (square peg: round hole)

Component of π_E toward Sun

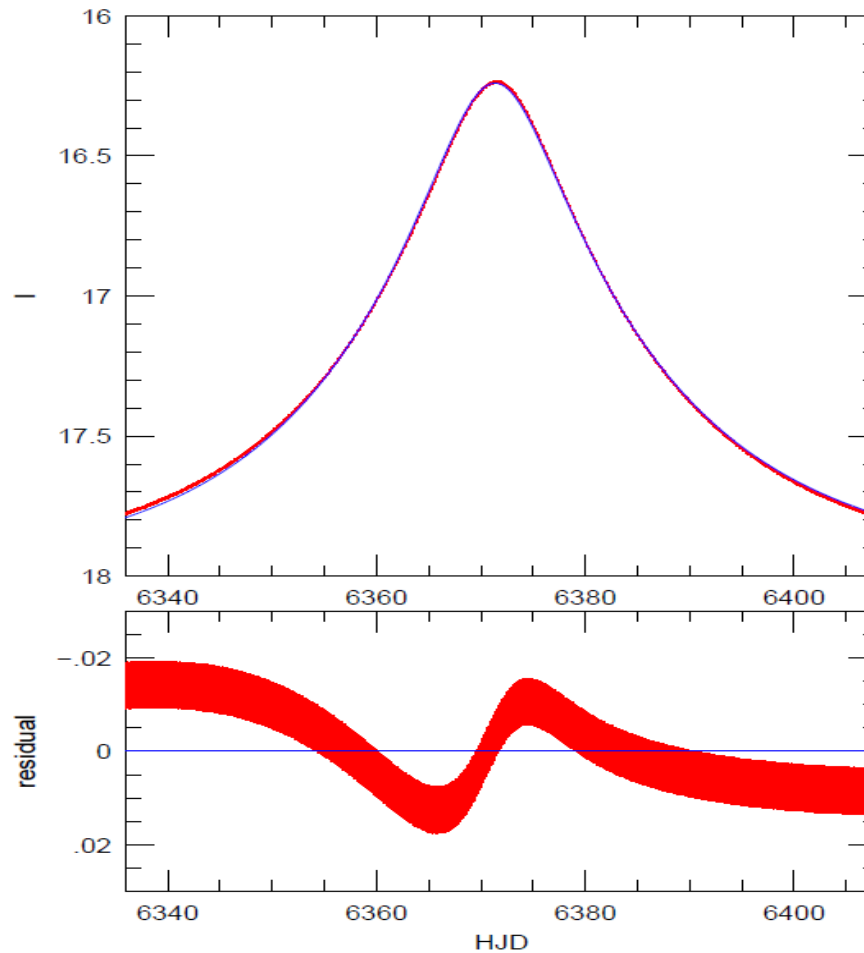

$\pi_{E, \text{perp}}$ (round peg: round hole)

Component of π_E perp to Sun

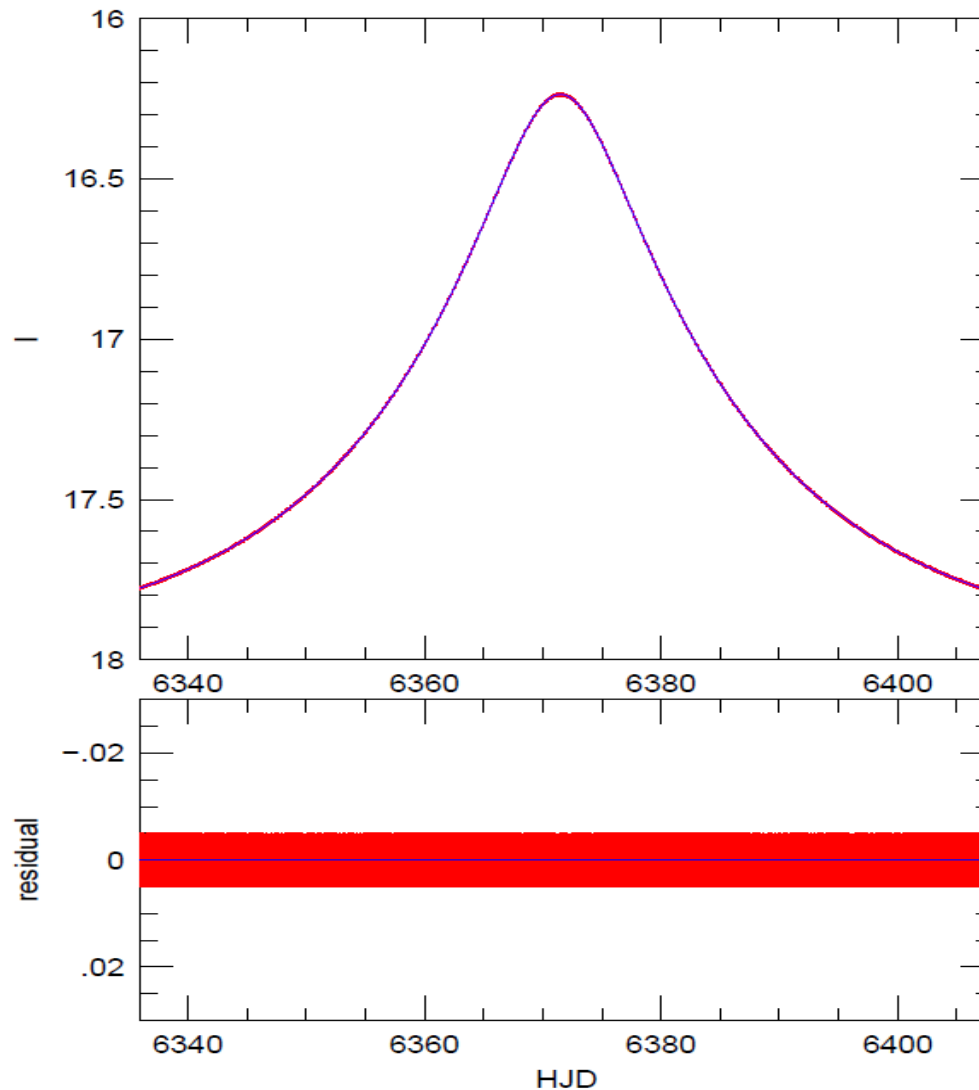

What can be done?

Focus on nearby
low-mass lenses

$$\pi_E^2 = \pi_{\text{rel}} / \kappa M; \kappa = 8 \text{mas} / M_{\text{sun}}$$

What can be done?

Focus on nearby
low-mass lenses

-Biased toward long t_E

$$\pi_E^2 = \pi_{\text{rel}} / \kappa M; \kappa = 8 \text{mas}/M_{\text{sun}}$$

$$\pi_{E,\text{parallel}} \quad (3^{\text{rd}} \text{ order in time})$$

$$\pi_{E,\text{perp}} \quad (4^{\text{th}} \text{ order in time})$$

$$u^2 = \sum_{i=0}^{\infty} C_i t^i$$

$$C_0 = u_0^2, \quad C_1 = 0, \quad C_2 = -\alpha u_0 \pi_{E,\perp} + t_E^{-2}$$

$$C_3 = \alpha \frac{\pi_{E,\parallel}}{t_E} + \frac{1}{4} \alpha^2 t_E u_0 \pi_E \times \pi_j,$$

$$C_4 = \frac{\alpha^2}{4} (\pi_E^2 + \pi_j \cdot \pi_E) + \frac{1}{12} \frac{\Omega_{\oplus}^2}{\alpha} u_0 \pi_{E,\perp},$$

Table 1
Monitored Events with Magnification $A > 100$

Name	A_{\max}	t_0 (HJD)	t_E	M/M_{\odot}	Method
OGLE-2007-BLG-224	2424	4233.7	7	0.056 ± 0.004	$M = \theta_E/\kappa\pi_E$
OGLE-2008-BLG-279	1600	4617.3	101	0.64 ± 0.10	$M = \theta_E/\kappa\pi_E$
OGLE-2005-BLG-169	800	3491.9	43	$0.49^{+0.23}_{-0.29}$	$\text{GM} \oplus \theta_E \oplus t_E$
MOA-2007-BLG-400	628	4354.6	14	$0.30^{+0.19}_{-0.12}$	$\text{GM} \oplus \theta_E \oplus t_E$
OGLE-2007-BLG-349	525	4348.6	121	~ 0.6	$M = \theta_E/\kappa\pi_E$
OGLE-2007-BLG-050	432	4222.0	68	0.50 ± 0.14	$M = \theta_E/\kappa\pi_E$
MOA-2008-BLG-310	400	4656.4	11	$\leq 0.67 \pm 0.14$	AO
OGLE-2006-BLG-109	289	3831.0	127	$0.51^{+0.05}_{-0.04}$	$M = \theta_E/\kappa\pi_E, \text{AO}$
OGLE-2005-BLG-188	283	3500.5	14	$0.16^{+0.21}_{-0.08}$	$\text{GM} \oplus \theta_E \oplus t_E$
MOA-2008-BLG-311	279	4655.4	18	$0.20^{+0.26}_{-0.09}$	$\text{GM} \oplus \theta_E \oplus t_E$
MOA-2008-BLG-105	267	4565.8	10		
OGLE-2006-BLG-245	217	3885.1	59		
OGLE-2006-BLG-265	211	3893.2	26		
OGLE-2007-BLG-423	157	4320.3	29		
OGLE-2005-BLG-417	108	3568.1	23		

OGLE-2006-BLG-109

Parallax+Finite-Source+Rotation+Blend

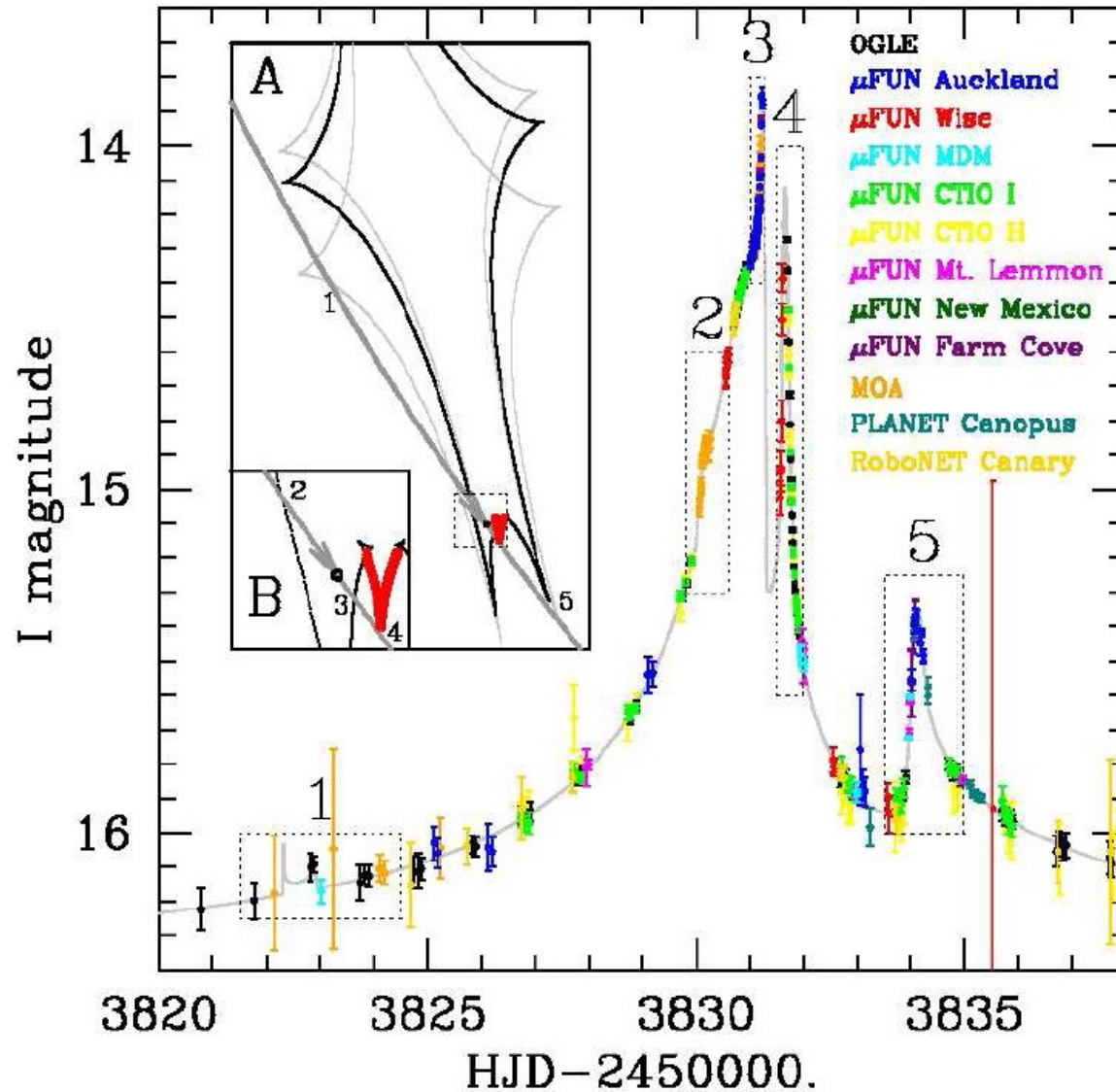

Gaudi et al. 2008, Science, 319, 927

Five Lightcurve Features

1+2+3+5=Saturn 4=Jupiter

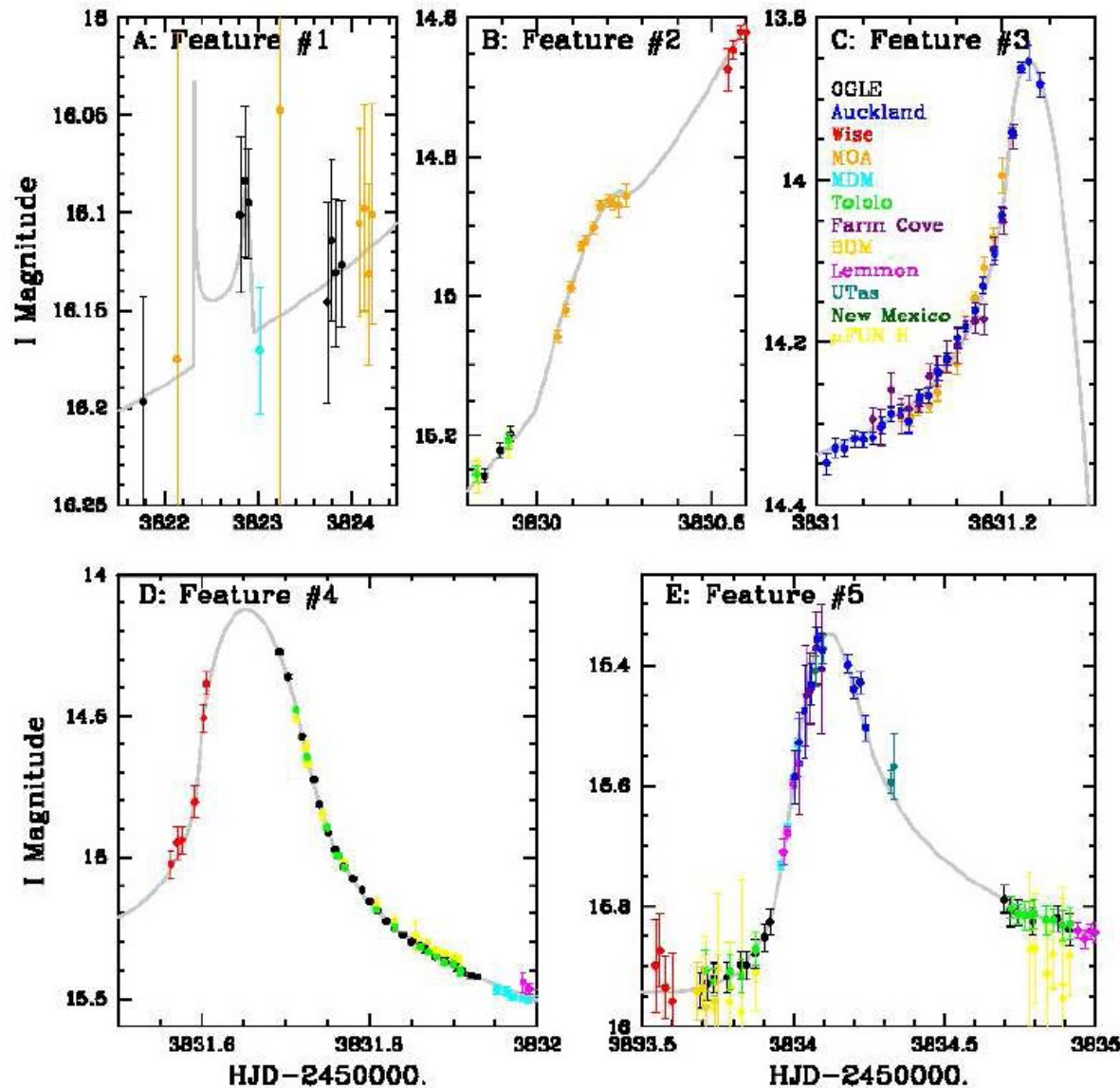

Generation 1.5: Survey+Followup

OGLE-2013-BLG-0341

Binary+ 2- M_{Earth} Planet at 1AU

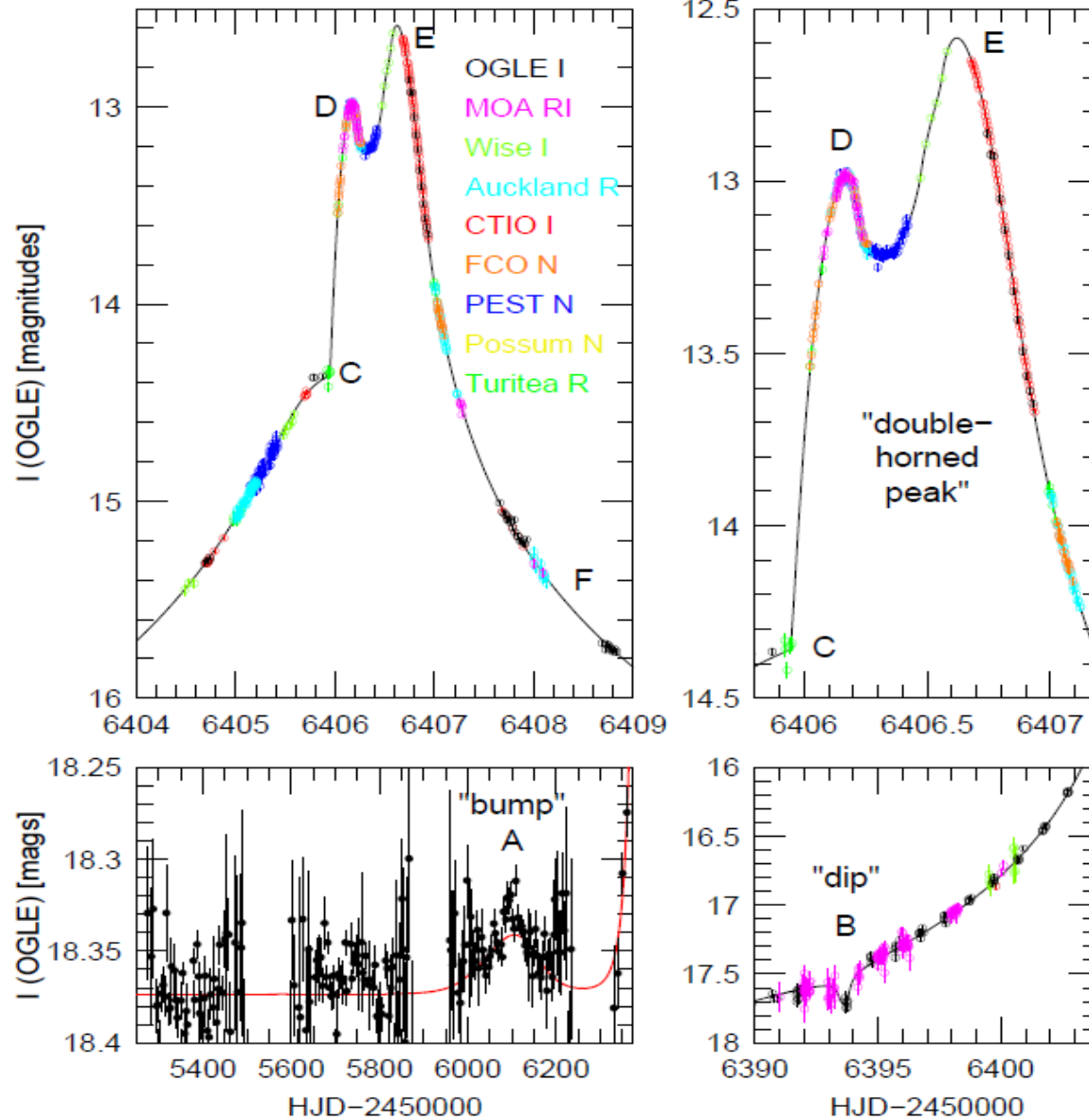

OGLE-2013-BLG-0341: Binary+Planet at 1AU

(Gould et al. 2014, Science, 345, 46)

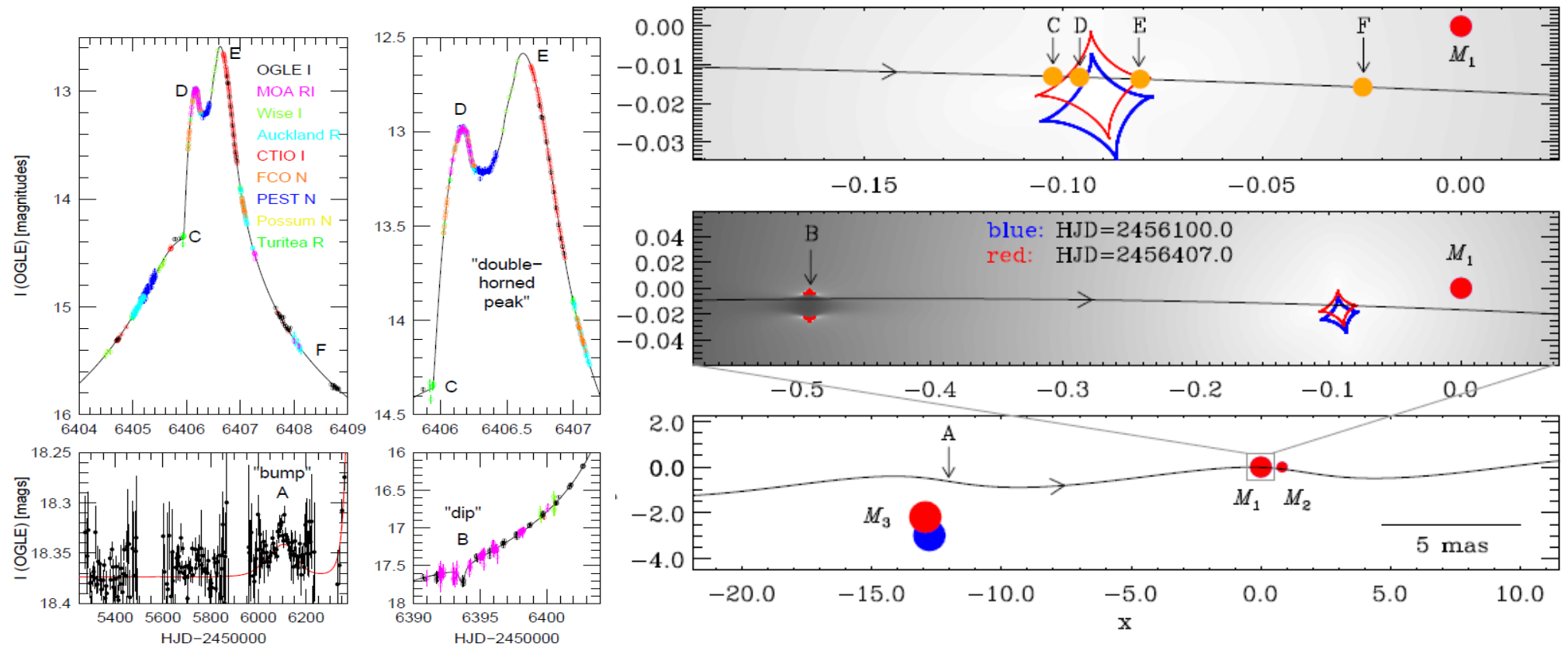

OGLE-2013-BLG-0341: Binary+Planet at 1AU

Parallax Clearly Detected!

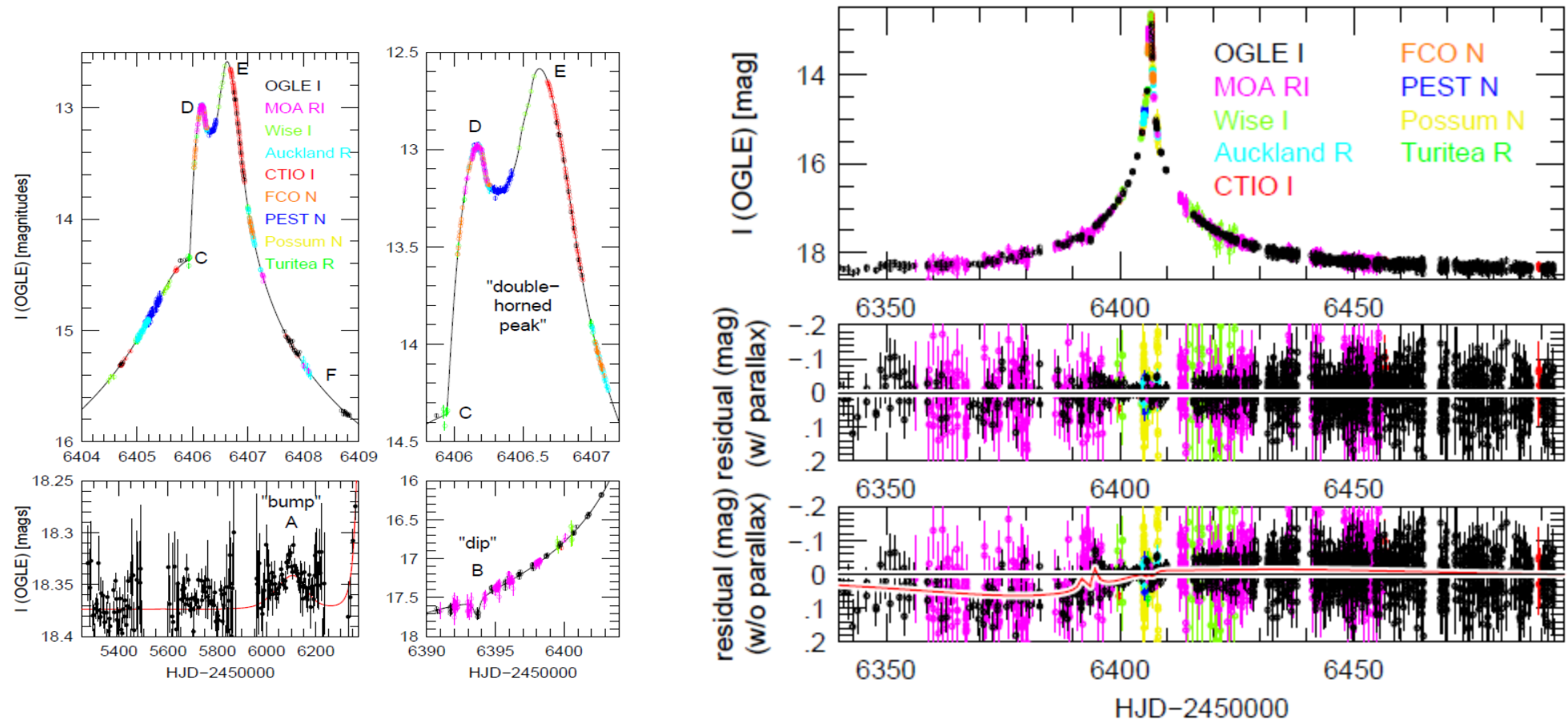

What can be done?

Focus on nearby
low-mass lenses

-Biased toward long t_E

$$\pi_E^2 = \pi_{\text{rel}} / \kappa M; \kappa = 8 \text{mas} / M_{\text{sun}}$$

$$\pi_{E,\text{parallel}} \text{ (3}^{\text{rd}} \text{ order in time)}$$

$$\pi_{E,\text{perp}} \text{ (4}^{\text{th}} \text{ order in time)}$$

Terrestrial Parallax

$$R_{\text{earth}} / \text{AU} = 1/23,000$$

OGLE-2007-BLG-224

Canaries South Africa Chile

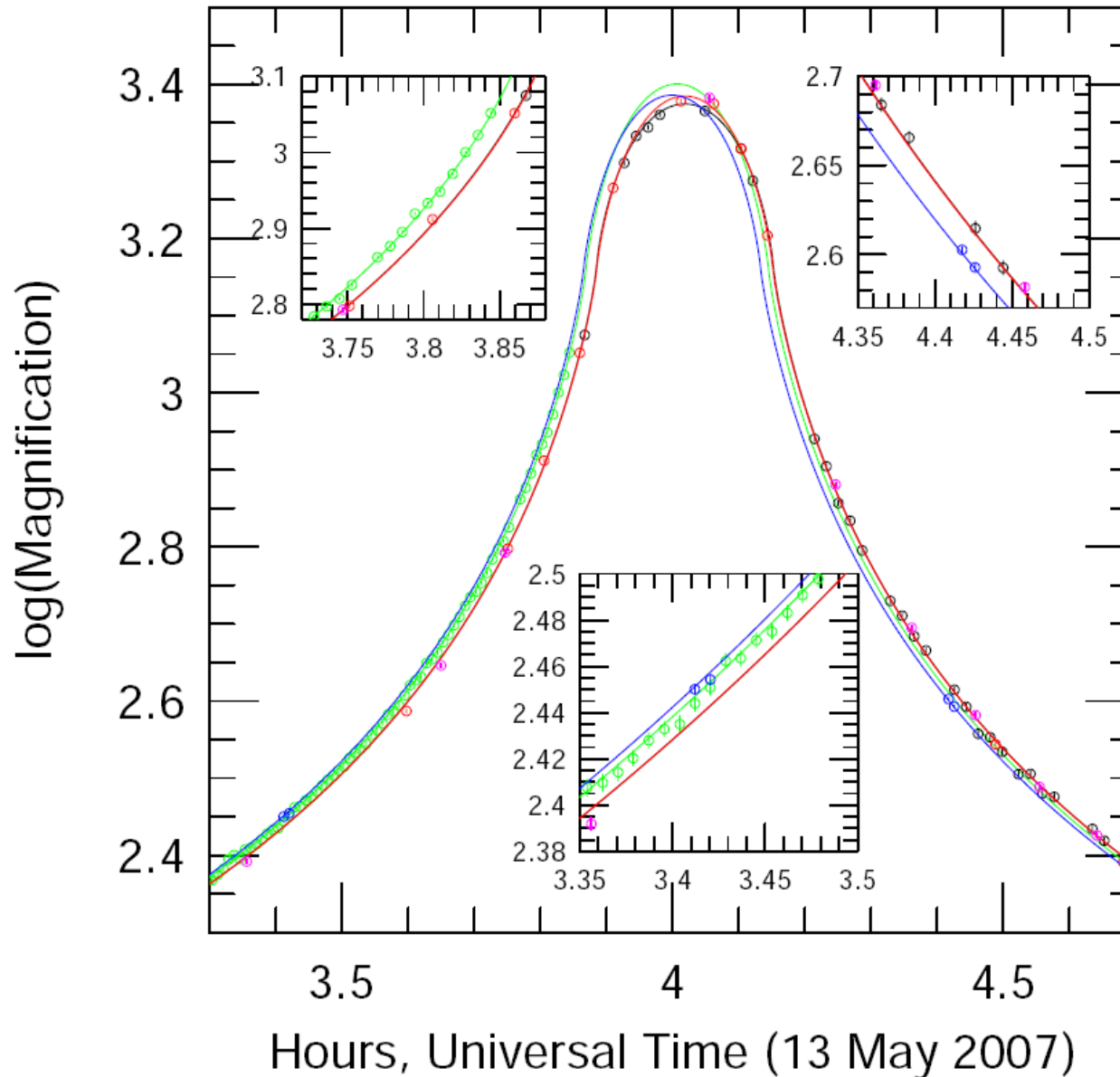

Terrestrial Parallax: Simultaneous Observations on Earth

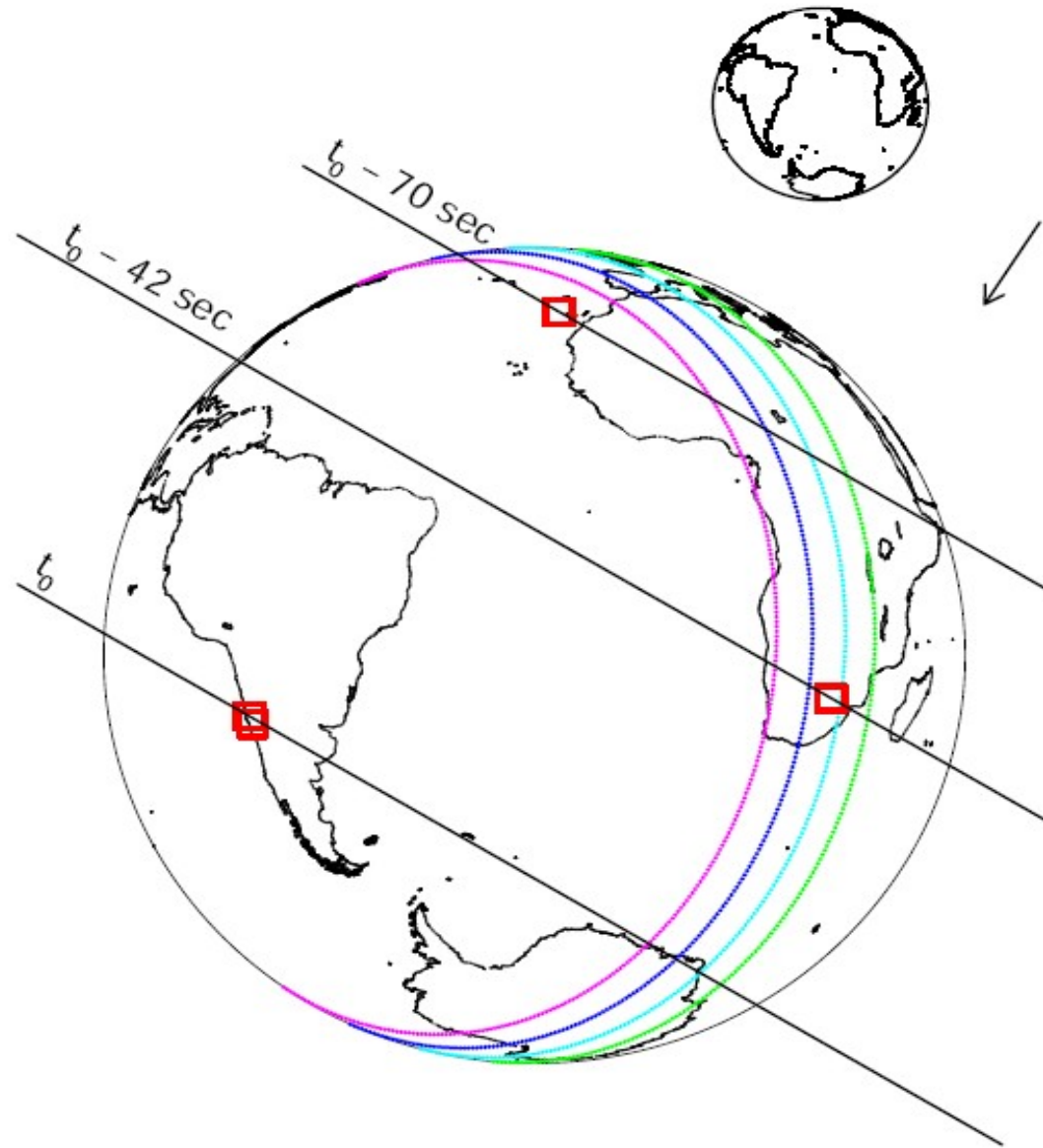

OGLE-2008-BLG-279:

$$A = 1600$$

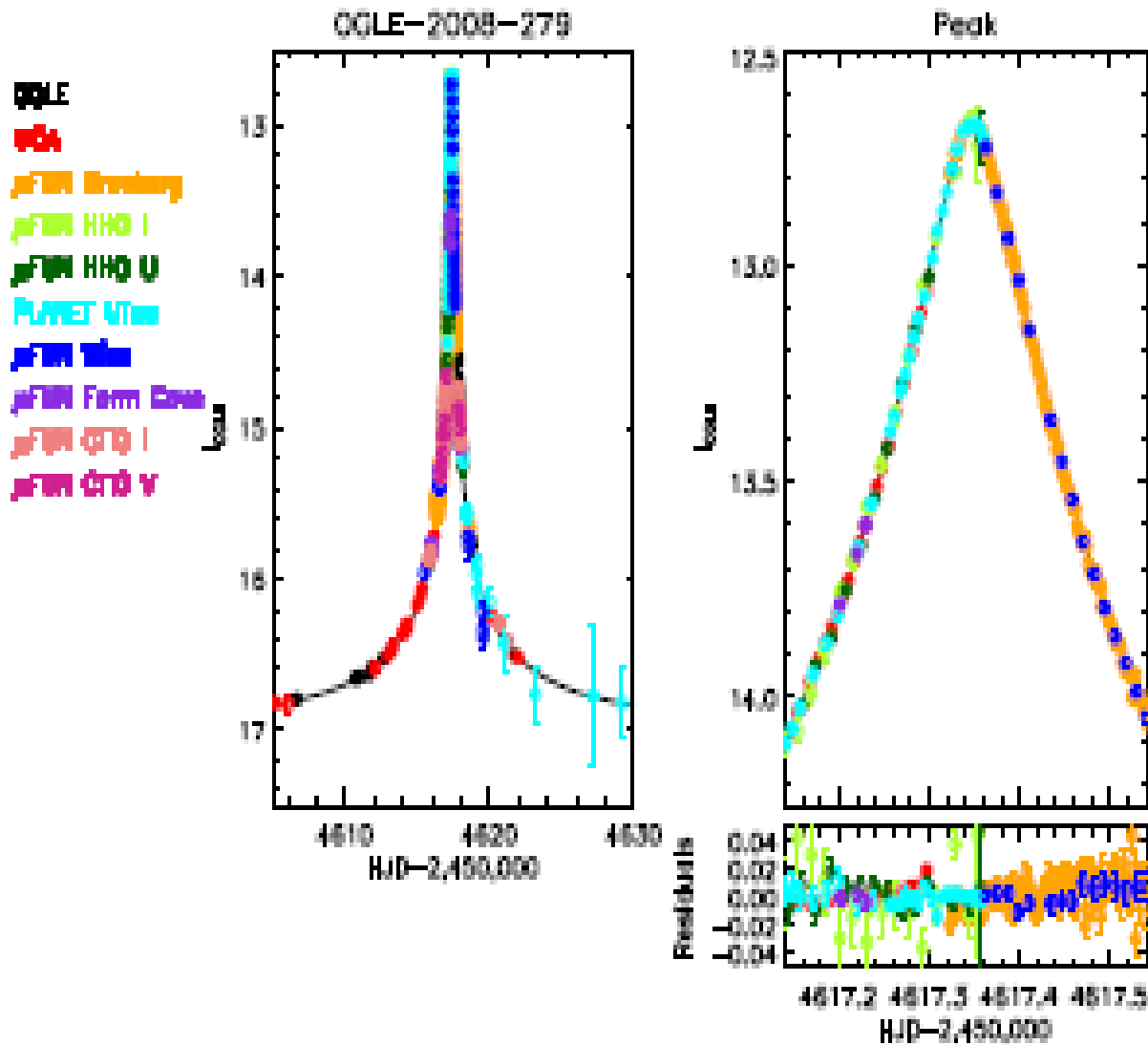

Yee et al. 2009, ApJ, 730, 2082

What can be done?

Focus on nearby
low-mass lenses

-Biased toward long t_E

Terrestrial Parallax

$$\pi_E^2 = \pi_{\text{rel}} / \kappa M; \kappa = 8 \text{mas} / M_{\text{sun}}$$

$$\pi_{E,\text{parallel}} \text{ (3}^{\text{rd}} \text{ order in time)}$$

$$\pi_{E,\text{perp}} \text{ (4}^{\text{th}} \text{ order in time)}$$

$$R_{\text{earth}} / \text{AU} = 1/23,000$$

Rare, Nearby

Events with Terrestrial Parallax

Name	M	D_L	μ	θ_*	$\rho \tilde{r}_E$	t_E	A_{\max}
	(M_\odot)	(kpc)	(mas yr^{-1})	(μas)	(R_\oplus)	(day)	
OGLE-2007-BLG-224	0.056	0.5	48.0	0.77	10	106	2400
OGLE-2008-BLG-279	0.64	4.0	2.7	0.54	100	7	1600

Gould & Yee 2012 ApJ, 764, 107

Events with Terrestrial Parallax

Name	M	D_L	μ	θ_*	$\rho \tilde{r}_E$	t_E	A_{\max}
	(M_\odot)	(kpc)	(mas yr $^{-1}$)	(μ as)	(R_\oplus)	(day)	
OGLE-2007-BLG-224	0.056	0.5	48.0	0.77	10	106	2400
OGLE-2008-BLG-279	0.64	4.0	2.7	0.54	100	7	1600

$$\pi_{\text{rel}} = \theta_E \pi_E = \frac{\text{AU}}{\rho \tilde{r}_E} \theta_* \gtrsim 0.28 \text{ mas} \frac{\theta_*}{0.6 \mu\text{as}}$$

Gould & Yee 2012 ApJ, 764, 107

Events with Terrestrial Parallax

Name	M	D_L	μ	θ_*	$\rho \tilde{r}_E$	t_E	A_{\max}
	(M_\odot)	(kpc)	(mas yr^{-1})	(μas)	(R_\oplus)	(day)	
OGLE-2007-BLG-224	0.056	0.5	48.0	0.77	10	106	2400
OGLE-2008-BLG-279	0.64	4.0	2.7	0.54	100	7	1600

$$\pi_{\text{rel}} = \theta_E \pi_E = \frac{\text{AU}}{\rho \tilde{r}_E} \theta_* \gtrsim 0.28 \text{ mas} \frac{\theta_*}{0.6 \mu\text{as}}$$

$$\Gamma = 2 \langle \mu \rangle \theta_* \int_0^{D_{\max}} dD_L D_L^2 n(D_L) = 1.6 \text{ Gyr}^{-1}$$

$$\times \left(\frac{\langle \mu \rangle}{10 \text{ mas yr}^{-1}} \right) \left(\frac{\theta_*}{0.6 \mu\text{as}} \right) \left(\frac{D_{\max}}{2.5 \text{ kpc}} \right)^3 \left(\frac{\langle n \rangle}{1 \text{ pc}^{-3}} \right)$$

Gould & Yee 2012 ApJ, 764, 107

Events with Terrestrial Parallax

Name	M	D_L	μ	θ_*	$\rho \tilde{r}_E$	t_E	A_{\max}
	(M_\odot)	(kpc)	(mas yr^{-1})	(μas)	(R_\oplus)	(day)	
OGLE-2007-BLG-224	0.056	0.5	48.0	0.77	10	106	2400
OGLE-2008-BLG-279	0.64	4.0	2.7	0.54	100	7	1600

$$\pi_{\text{rel}} = \theta_E \pi_E = \frac{\text{AU}}{\rho \tilde{r}_E} \theta_* \gtrsim 0.28 \text{ mas} \frac{\theta_*}{0.6 \mu\text{as}}$$

$$\Gamma = 2 \langle \mu \rangle \theta_* \int_0^{D_{\max}} dD_L D_L^2 n(D_L) = 1.6 \text{ Gyr}^{-1}$$

$$\times \left(\frac{\langle \mu \rangle}{10 \text{ mas yr}^{-1}} \right) \left(\frac{\theta_*}{0.6 \mu\text{as}} \right) \left(\frac{D_{\max}}{2.5 \text{ kpc}} \right)^3 \left(\frac{\langle n \rangle}{1 \text{ pc}^{-3}} \right)$$

$$(1/4)(1/10)(1/2)\Gamma N T = 0.1$$

$$(N = 5e8; T = 10 \text{ yr})$$

Gould & Yee 2012 ApJ, 764, 107

MOA Point-Lens Events

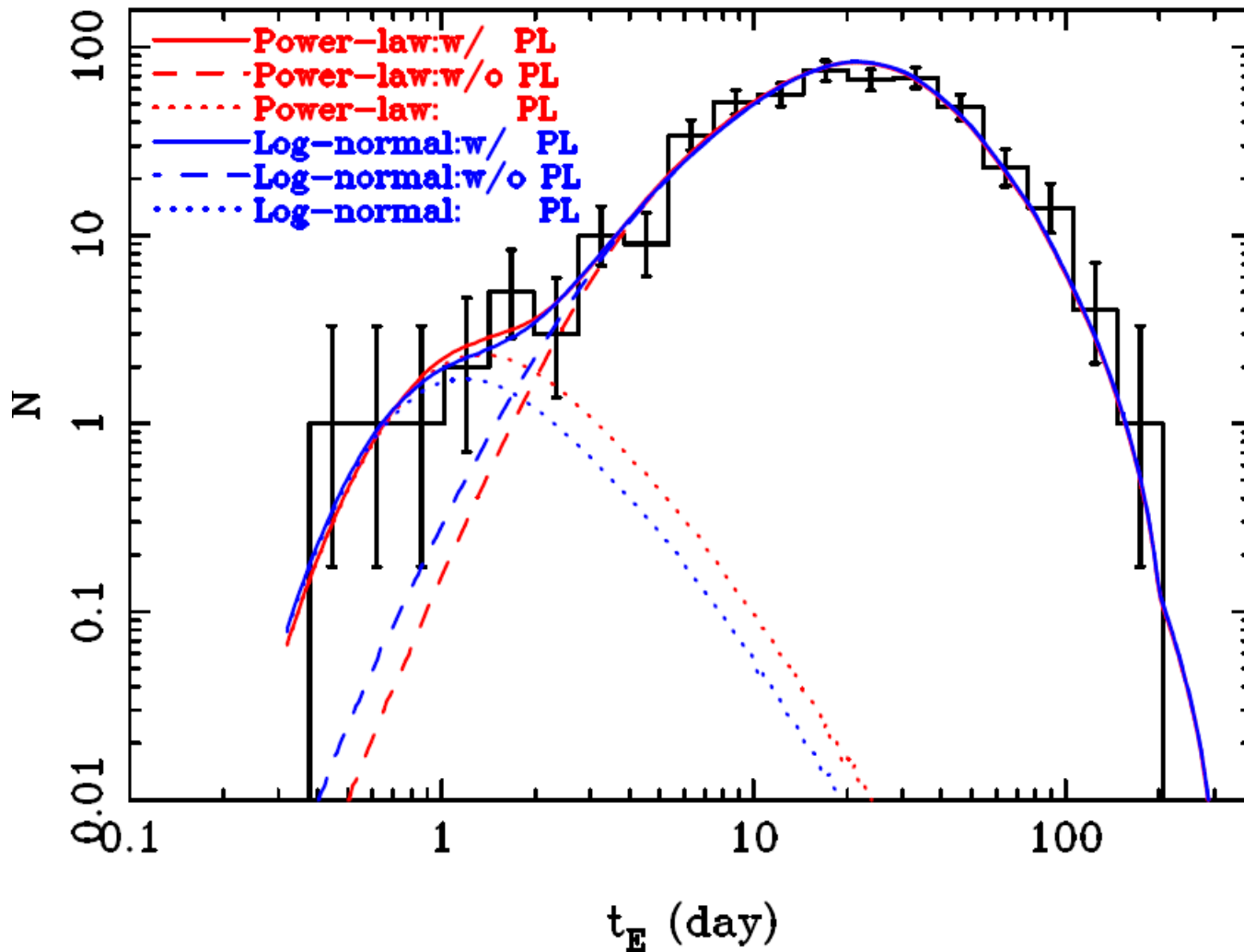

Sumi et al. 2011, Nature, 473, 349

FFP Best-Fit Characteristics

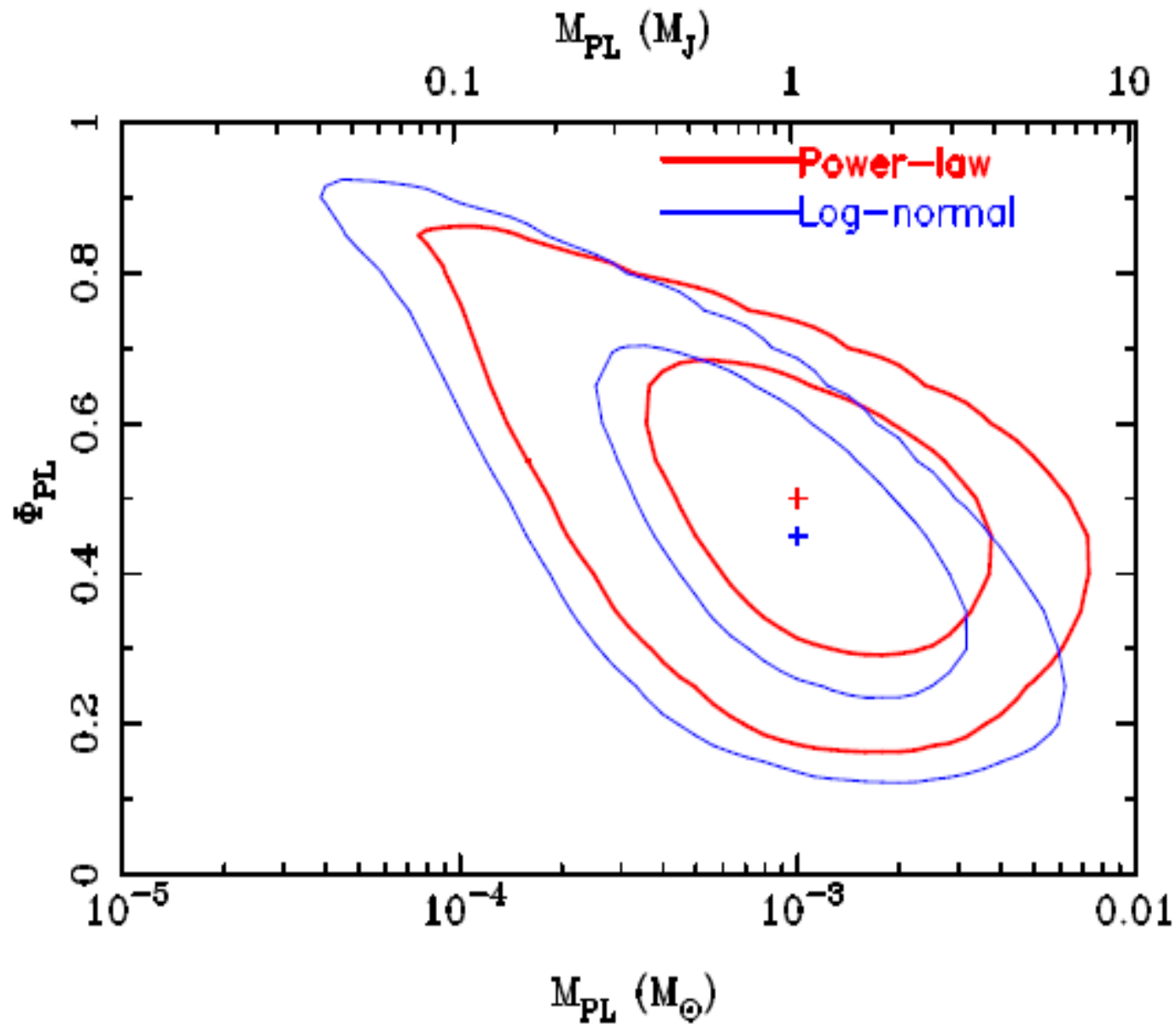

Free-Floating Planets

Point-Lens Events w/o FFPs (short)

$$\Gamma \propto \int dM F(M) \int dD_L D_L^2 n(D_L) \int d^2\mu \mu f_\mu(\mu) \theta_E(M, D_L)$$

$$t_E = \frac{\theta_E}{\mu}, \quad \theta_E = \sqrt{\kappa M \pi_{\text{rel}}}$$

$$t_E \text{ small} \Rightarrow D_{LS} \ll D_S$$

$$dD_L D_L^2 n(D_L) \rightarrow dD_{LS} D_S^2 n(D_S) = K dD_{LS}; \quad \theta_E \rightarrow \sqrt{\frac{\kappa \text{AU} M}{D_S^2} D_{LS}}$$

$$\Gamma \propto \int dM F(M) M^{1/2} \int d^2\mu \mu f_\mu(\mu) \int d \ln D_{LS} D_{LS}^{3/2}$$

$$\frac{d\Gamma}{d \ln t_E} \propto t_E^3 \int dM F(M) M^{-1} \int d^2\mu \mu f_\mu(\mu)$$

MOA Point-Lens Events

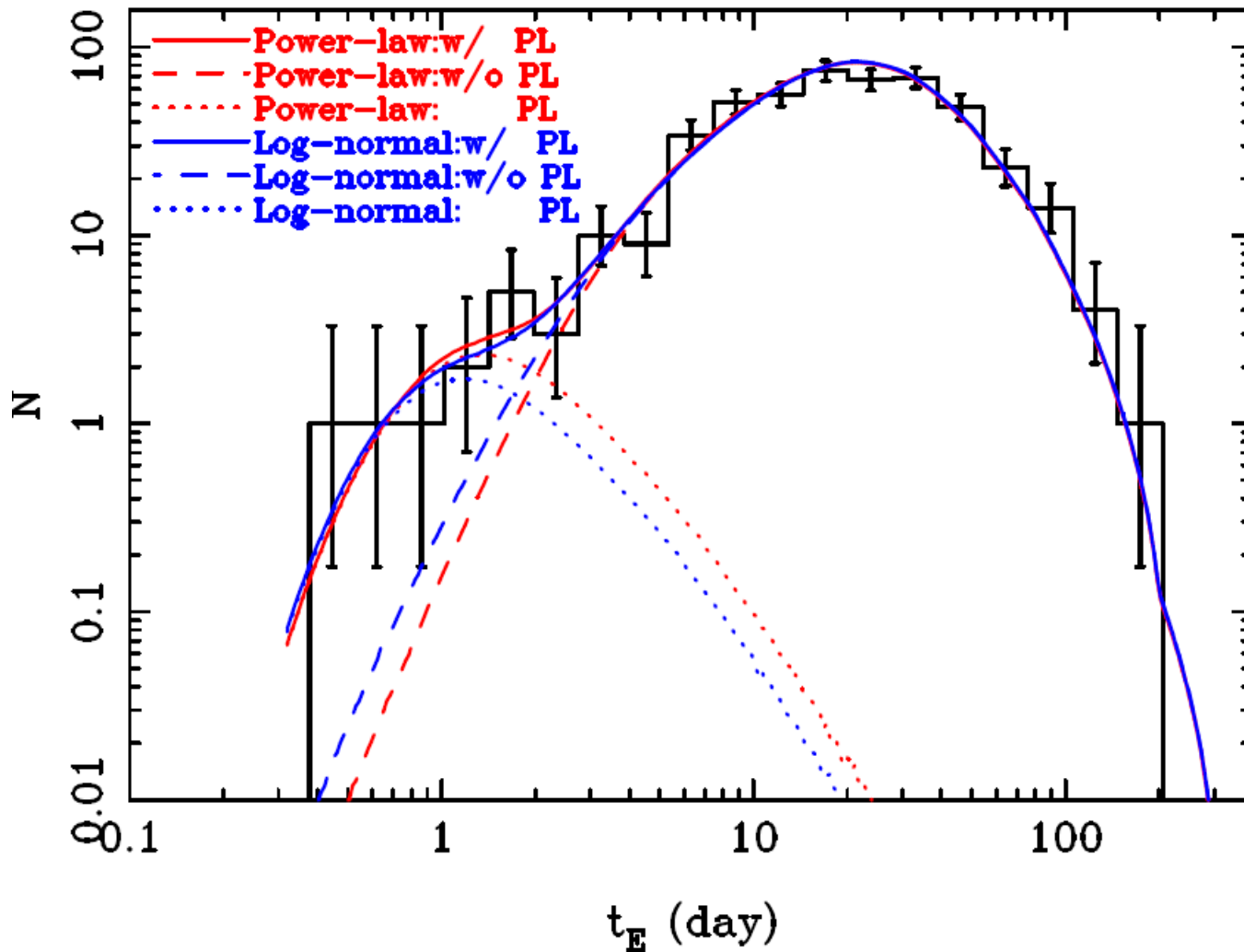

Sumi et al. 2011, Nature, 473, 349

Satellite Parallaxes (Panacea?)

ON THE POSSIBILITY OF DETERMINING THE DISTANCES
AND MASSES OF STARS FROM THE GRAVITATIONAL
LENS EFFECT

S. Refsdal

(Communicated by Professor S. Rosseland)

(Received 1966 June 6)

Summary

It is shown that the distance and the mass of a star which acts as a gravitational lens can be determined if the lens effect can be observed from the Earth and from at least one distant space observatory. The distance from the Earth to the space observatory will usually have to be of the order of 5% of one astronomical unit or more.

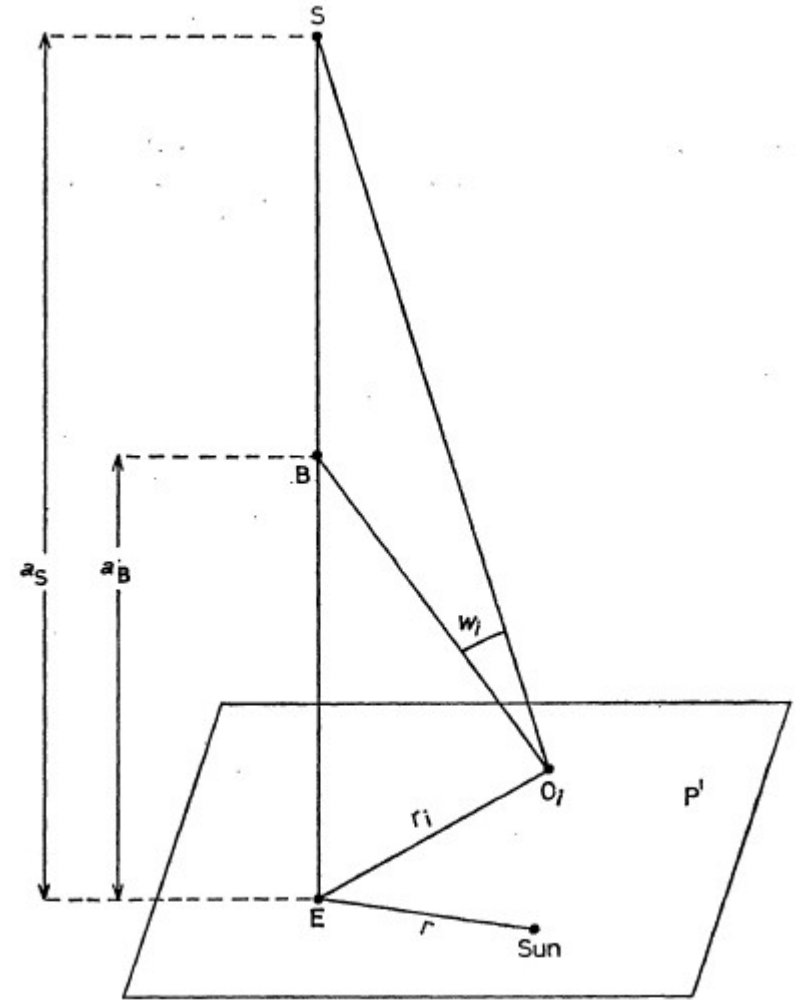
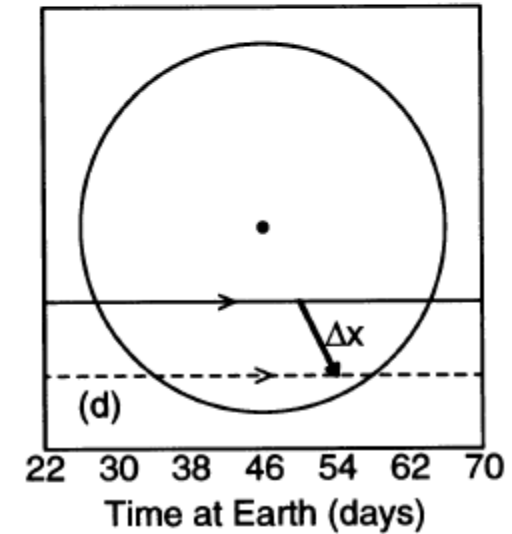
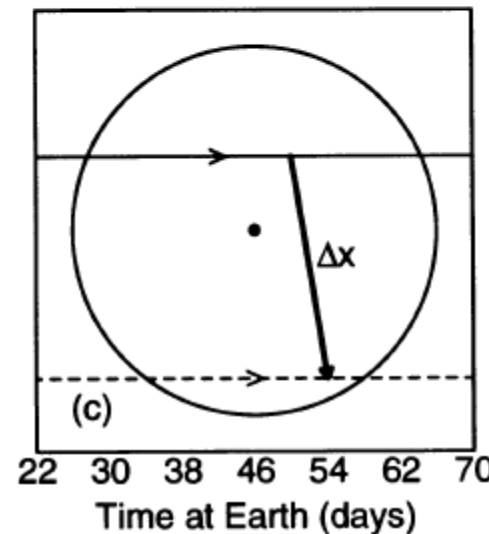
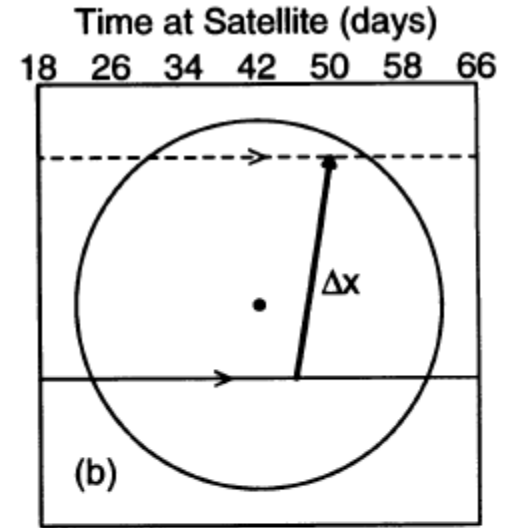
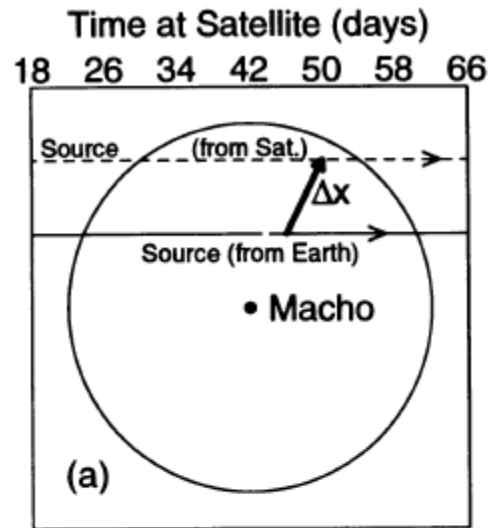
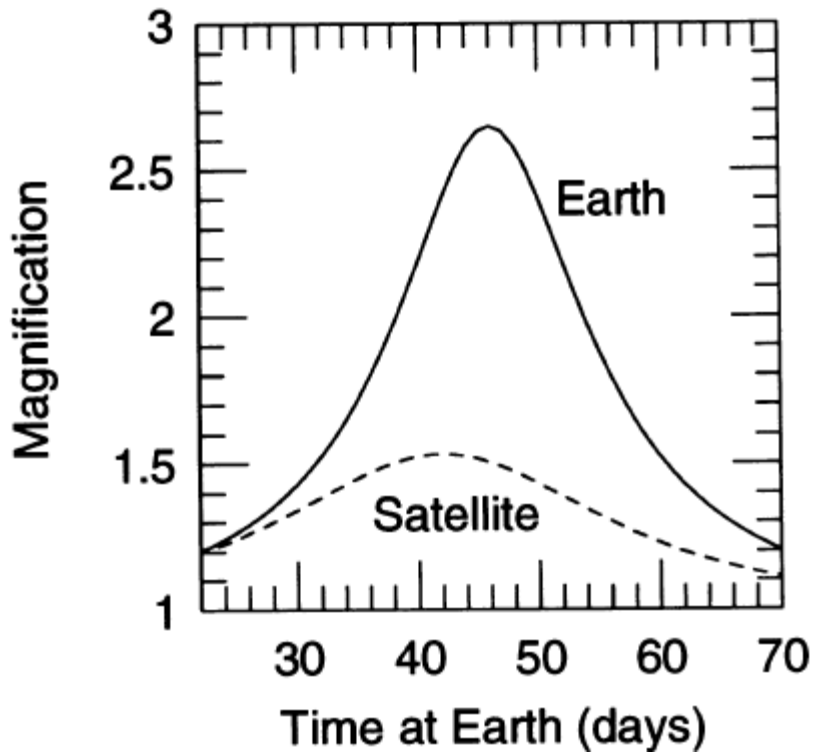

FIG. 1.

Satellite Parallaxes (Panacea?)



From a paper written 15 years ago ...

THE ASTROPHYSICAL JOURNAL, 514:869–877, 1999 April 1

© 1999. The American Astronomical Society. All rights reserved. Printed in U.S.A.

MICROLENS PARALLAXES WITH SIRTf

ANDREW GOULD¹

Ohio State University, Department of Astronomy, 174 West 18th Avenue, Columbus, OH 43210; gould@astronomy.ohio-state.edu

Received 1998 July 27; accepted 1998 November 2

$$t_{0,S} = t_{0,\oplus} + \Delta t_0, \quad \frac{\sigma_{\Delta u_y}}{\Delta u} = \frac{\sigma_\gamma}{\gamma \sec \phi}$$

$$\frac{\Delta t_0}{t_{e,\oplus}} = \Delta u_x \cos \theta - 2(\Omega_\oplus t_{e,\oplus})^{-2} \gamma_\oplus \sin^2 \theta; \quad (13) \quad = 0.17 N^{-1/2} \frac{\sigma_0}{0.01} \frac{\tilde{v}}{275 \text{ km s}^{-1}} \left(\frac{t_e}{40 \text{ days}} \right)^{-3/2} \frac{S(\beta)}{8}. \quad (21)$$

$$\beta_S = |\beta_\oplus \pm \Delta\beta|, \quad \Delta\beta = \Delta u_x \sin \theta + (\Omega_\oplus t_{e,\oplus})^{-2} \gamma_\oplus \sin 2\theta; \quad (14) \quad b_{ij} \left(\frac{t_0}{t_e}, \gamma \right) = \frac{64}{u^5 (u^2 + 4)^{5/2} (u^2 + 2) \sigma_0^2} \begin{pmatrix} 2\tau^2 & -\tau^4 \\ -\tau^4 & \tau^6/2 \end{pmatrix}, \quad (22)$$

$$t_{e,S} = t_{e,\oplus} + \Delta t_e,$$

$$\frac{\Delta t_e}{t_{e,\oplus}} = \Delta u_x \Omega_\oplus t_{e,\oplus} \sin \theta + (\Omega_\oplus t_{e,\oplus})^{-1} \gamma_\oplus \sin 2\theta; \quad (15) \quad \frac{\sigma_{t_0}}{t_e} \sim \left(\frac{25}{12} \right)^{1/2} \beta \sigma_*, \quad \sigma_* = \left(\frac{5}{3} \right)^{1/4} \beta^{1/2} \sigma_0$$

$$\gamma_S = \Delta u_x (\Omega_\oplus t_{e,\oplus})^2 \cos \theta + \gamma_\oplus \cos 2\theta. \quad (16) \quad \left[\text{at } \tau = \left(\frac{2}{3} \right)^{1/2} \beta \right], \quad (23)$$

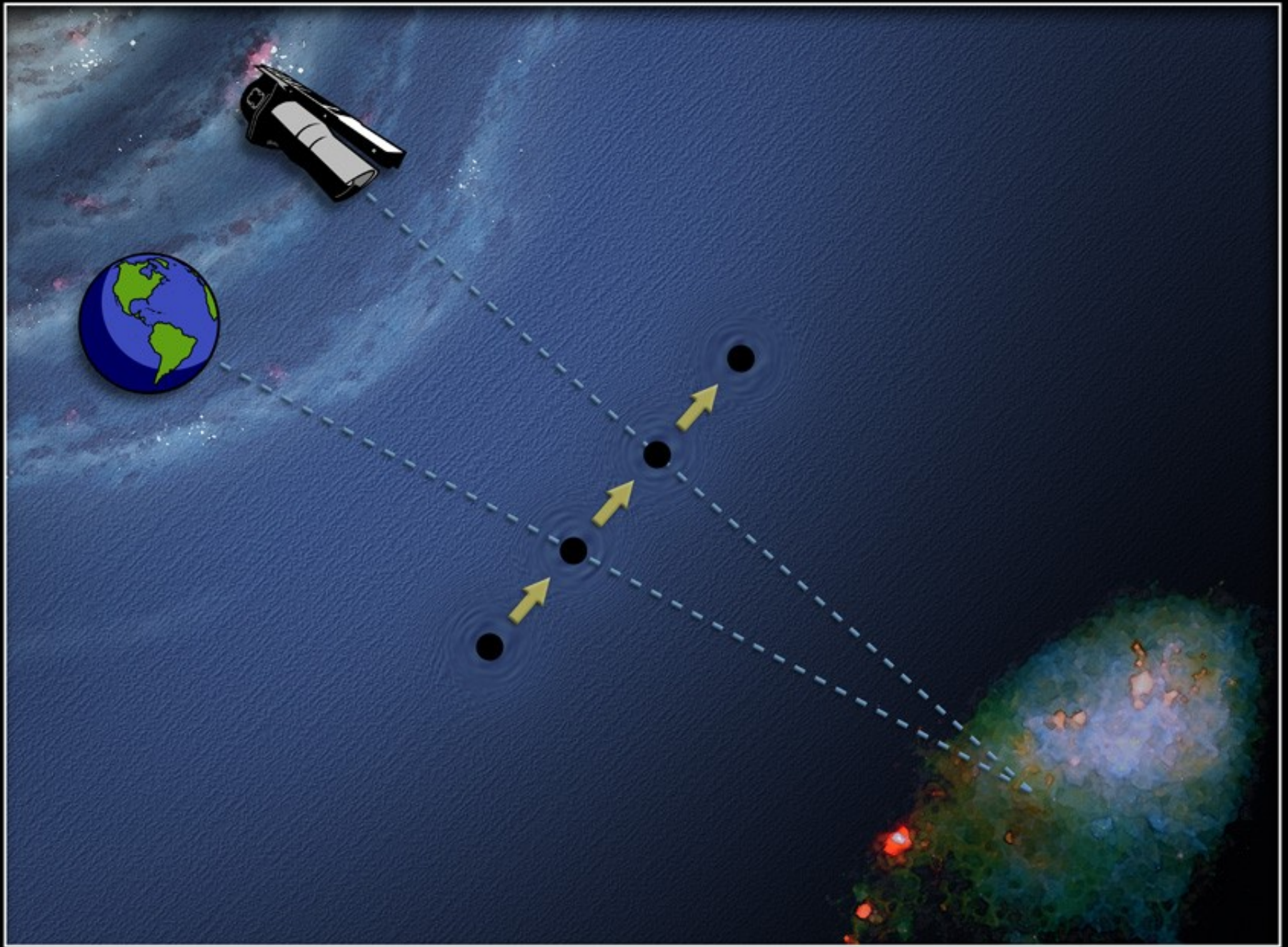

Microlens Parallax Observations of OGLE-2005-SMC-001

NASA / JPL-Caltech / S. Dong (Ohio State University)

Spitzer Space Telescope • IRAC

ssc2007-XX

Satellite Parallaxes (Panacea?)

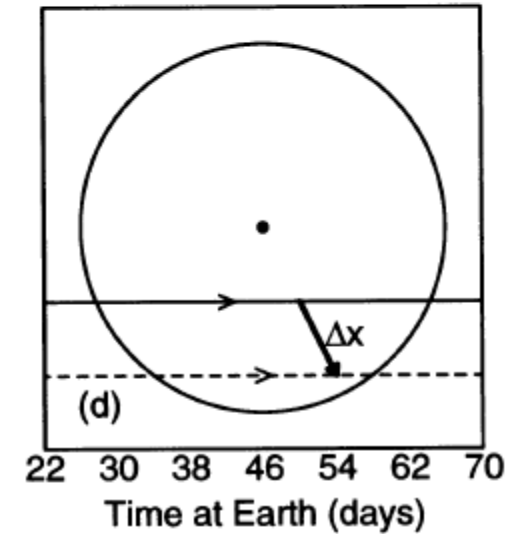
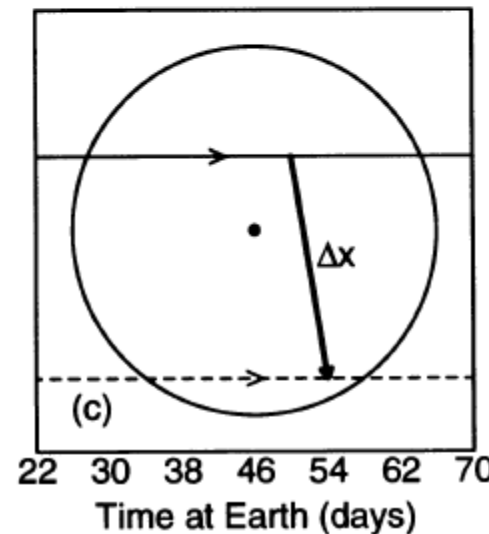
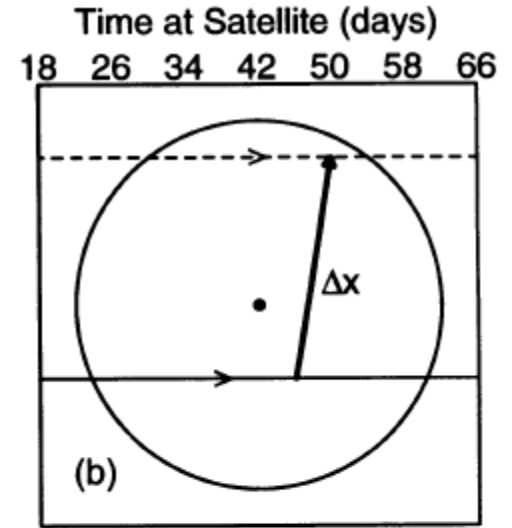
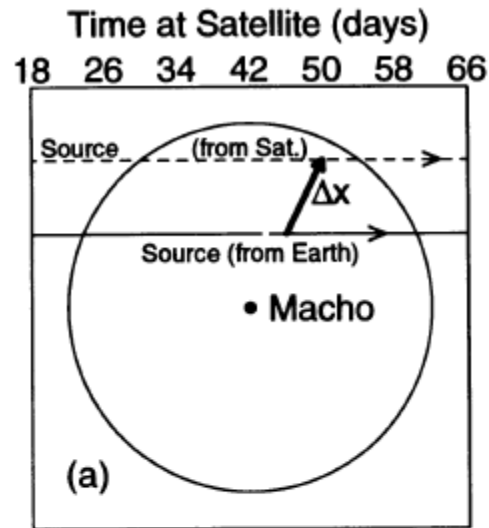
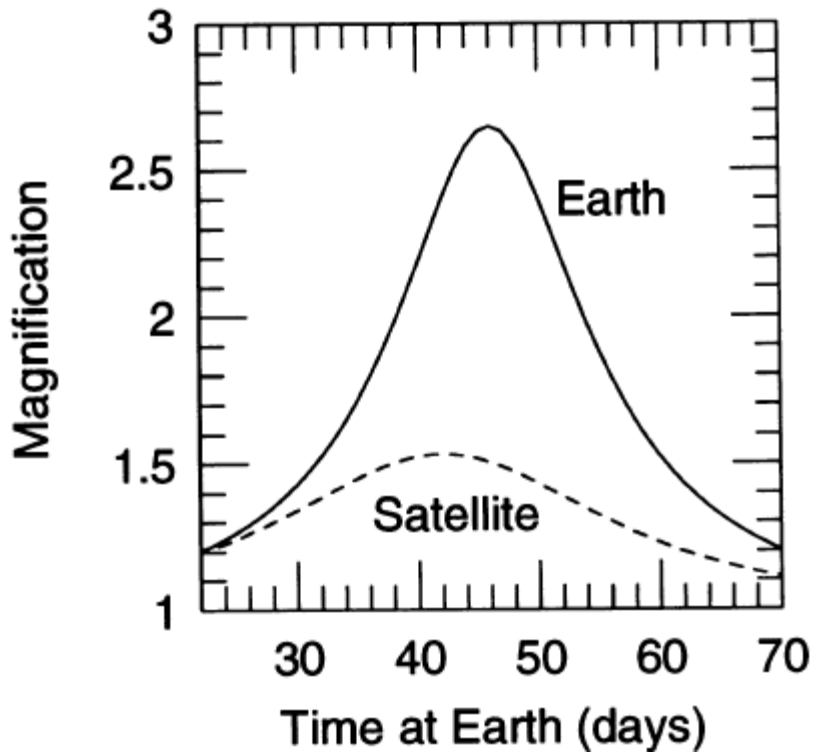

100-Hr Spitzer Feasibility Study 2014

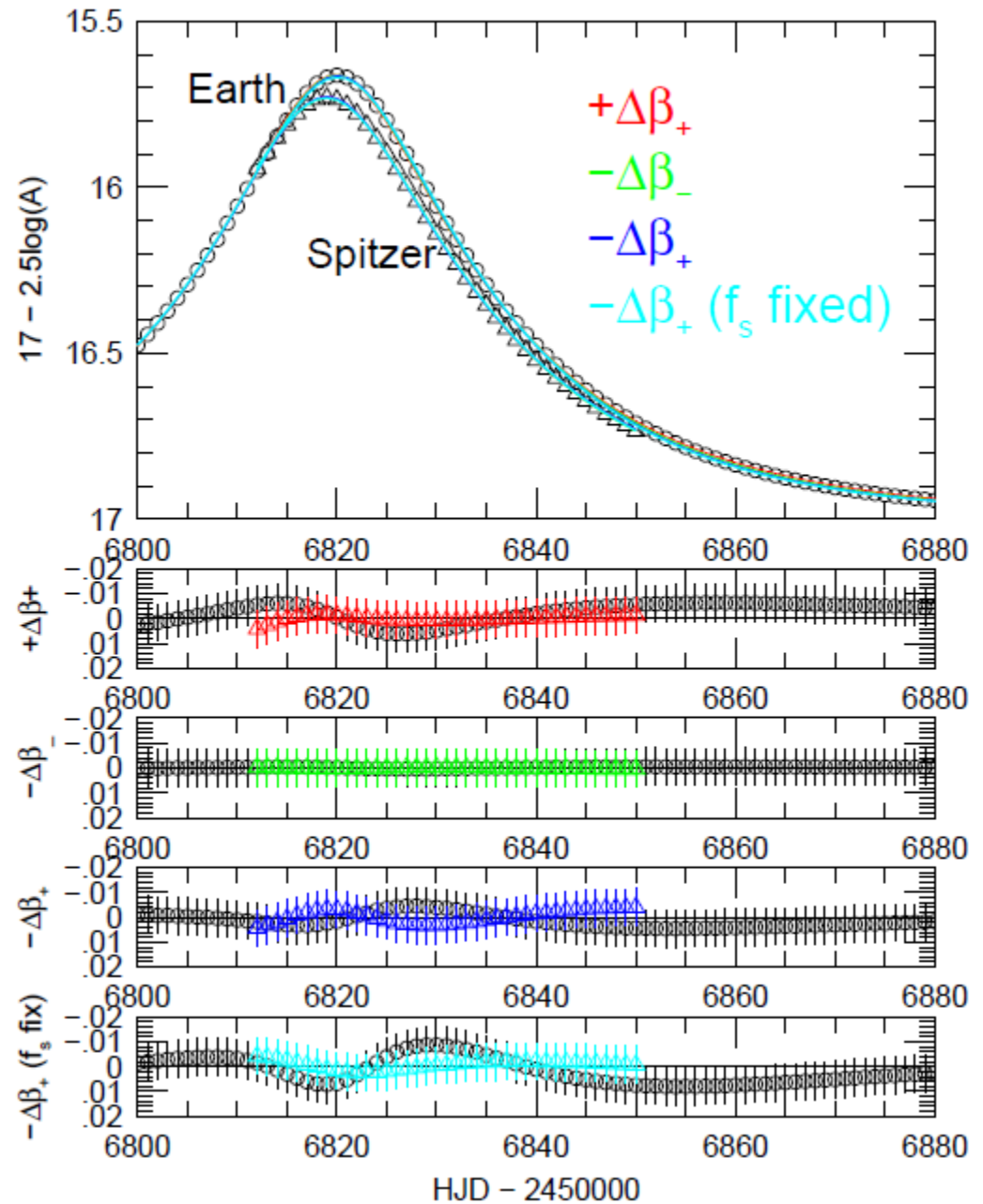
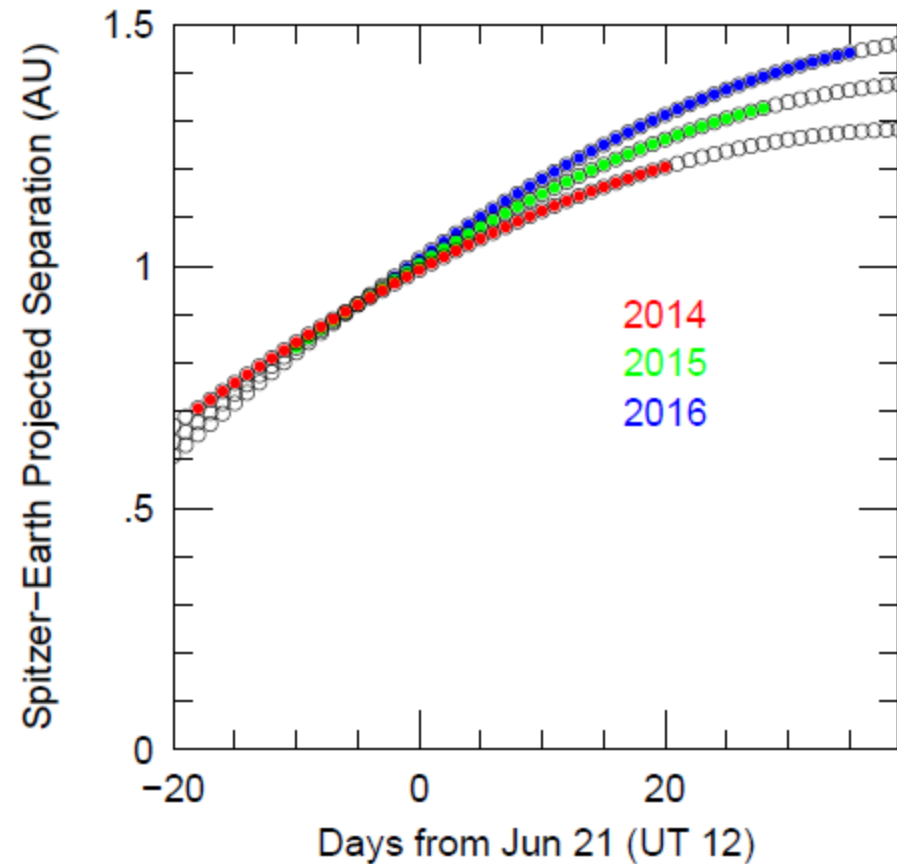

100-Hr Spitzer Feasibility Study 2014

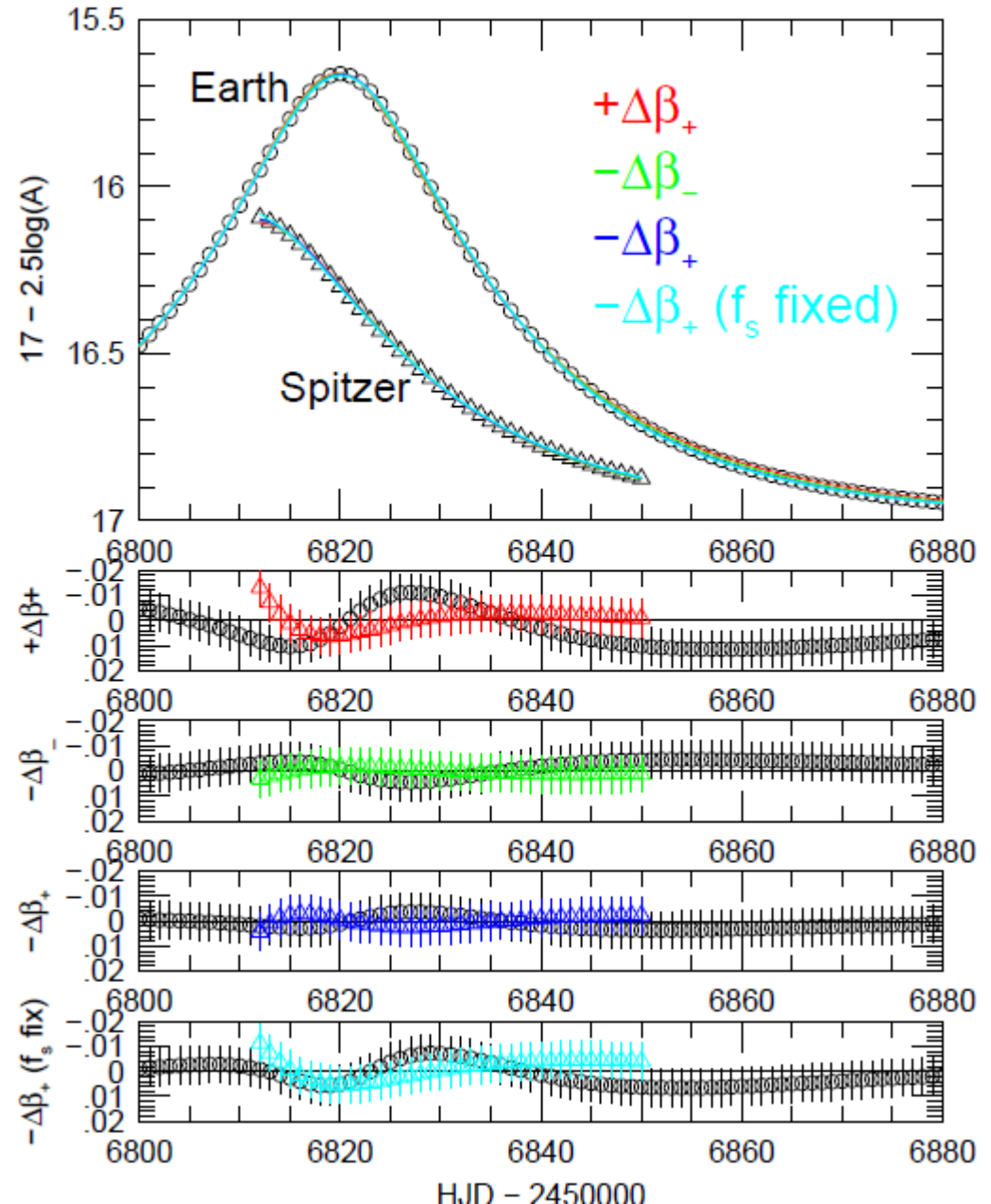
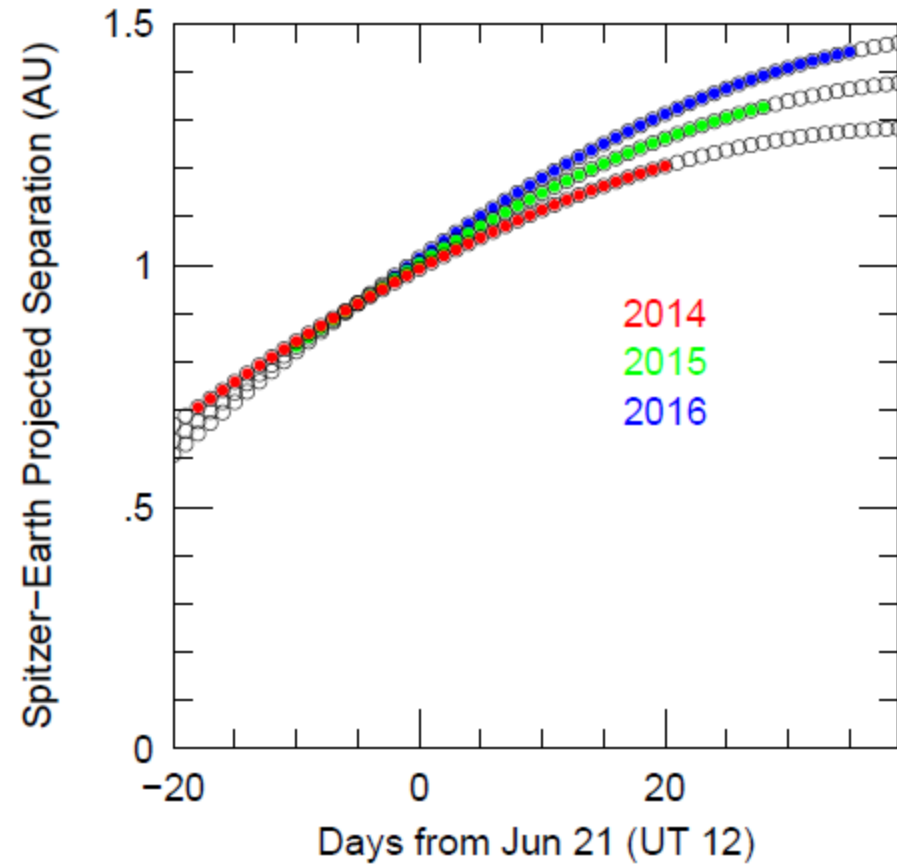

OGLE-2014-BLG-0939: First Isolated Lens with Spitzer Parallax

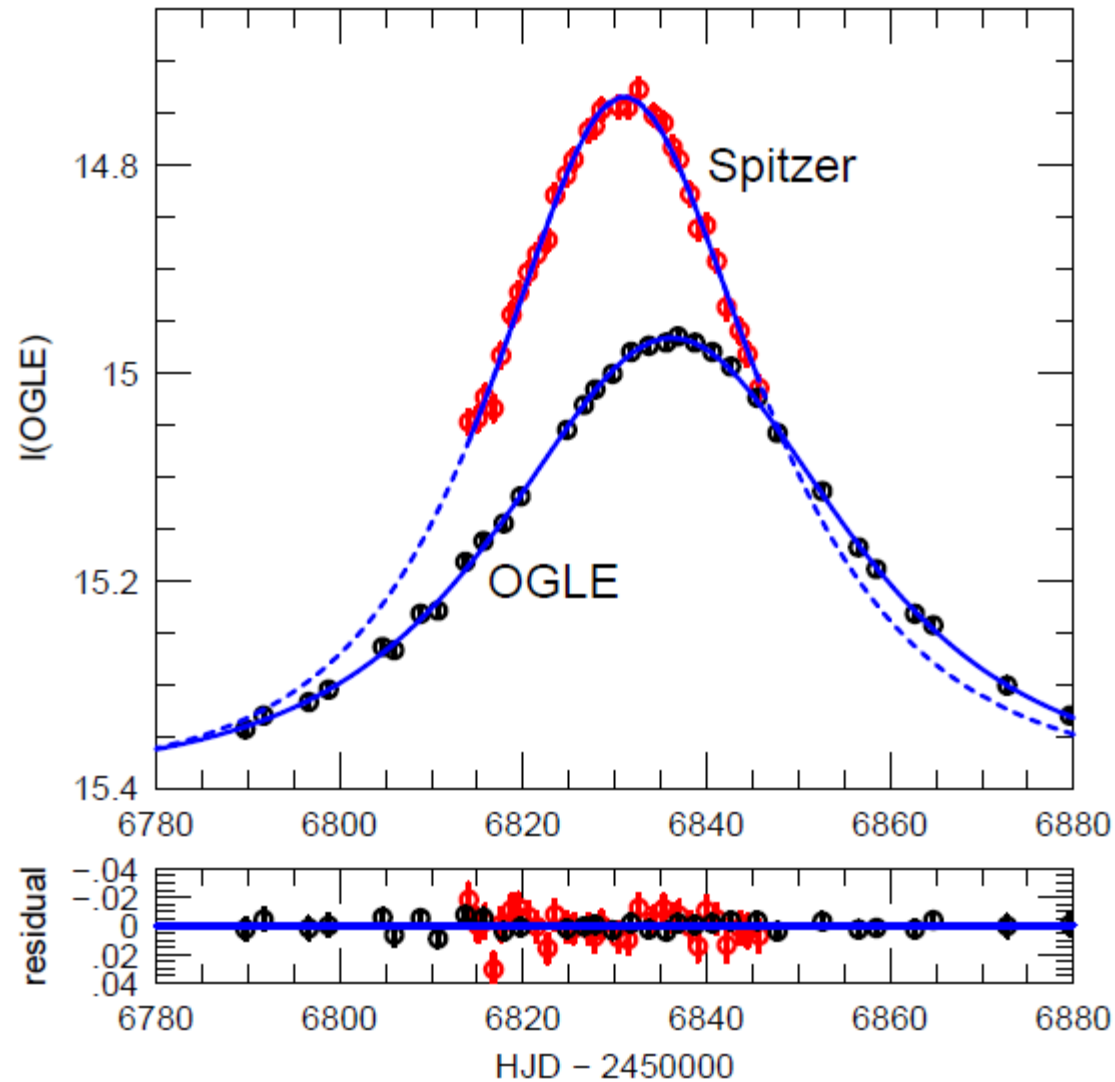

Yee et al. 2015, ApJ, 802, 76

OGLE-2014-BLG-0939: Refsdal (1966) 4-fold Degeneracy

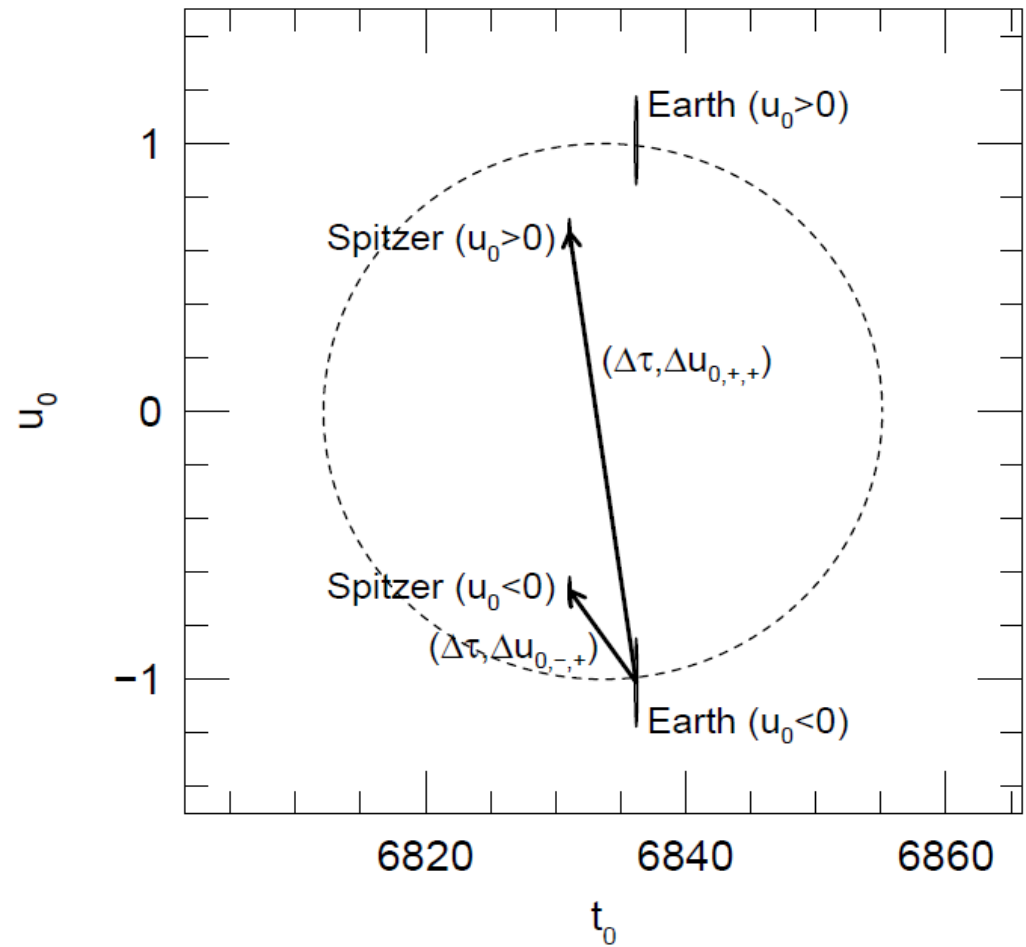
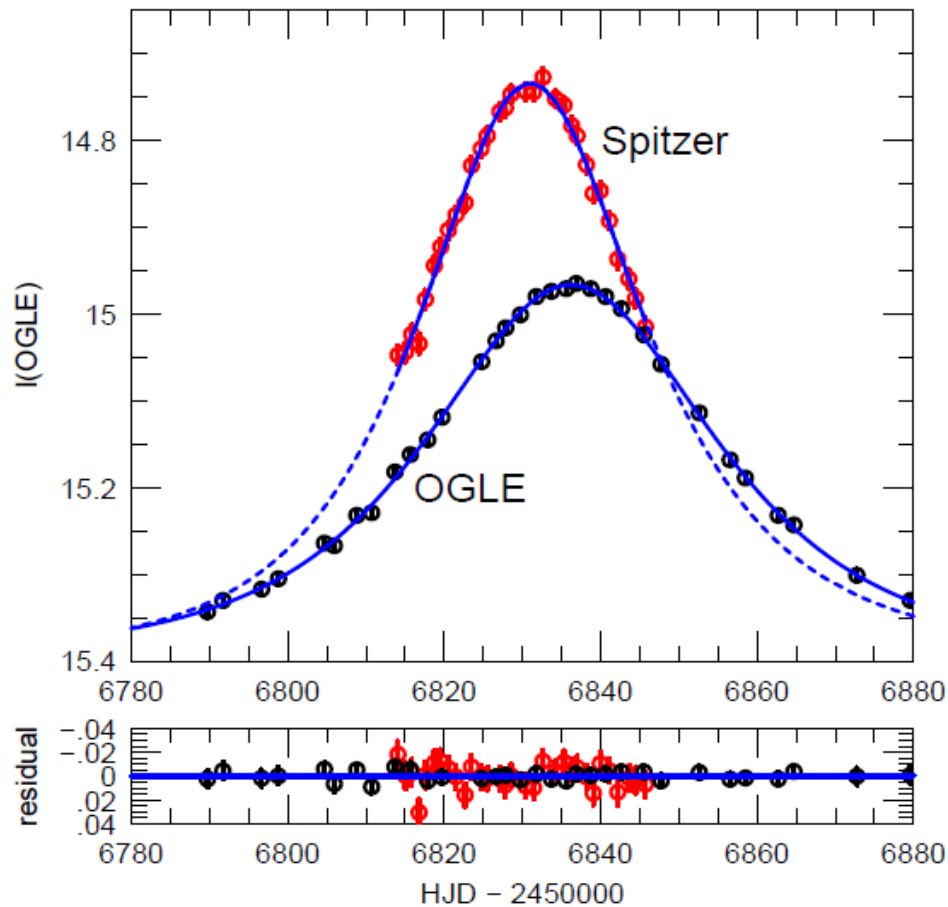

Yee et al. 2015, ApJ, 802, 76

OGLE-2014-BLG-0939: 4-fold Degeneracy Expressed in Velocity

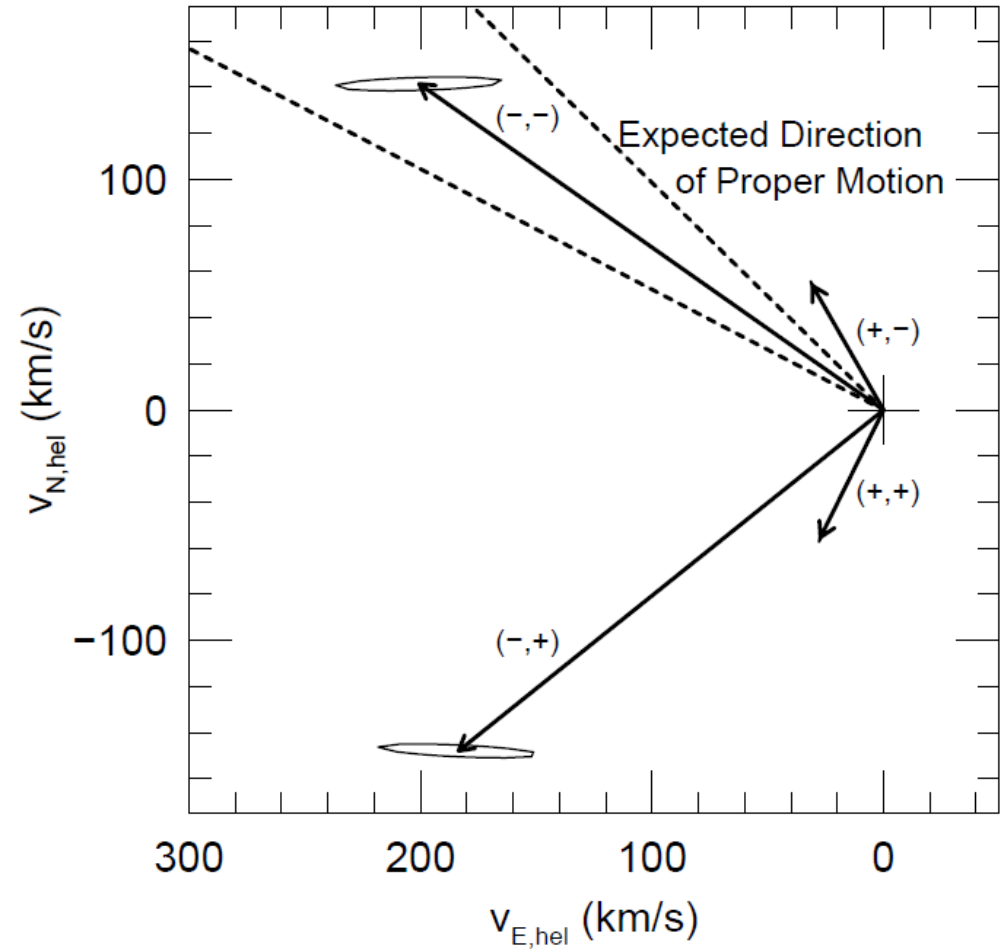
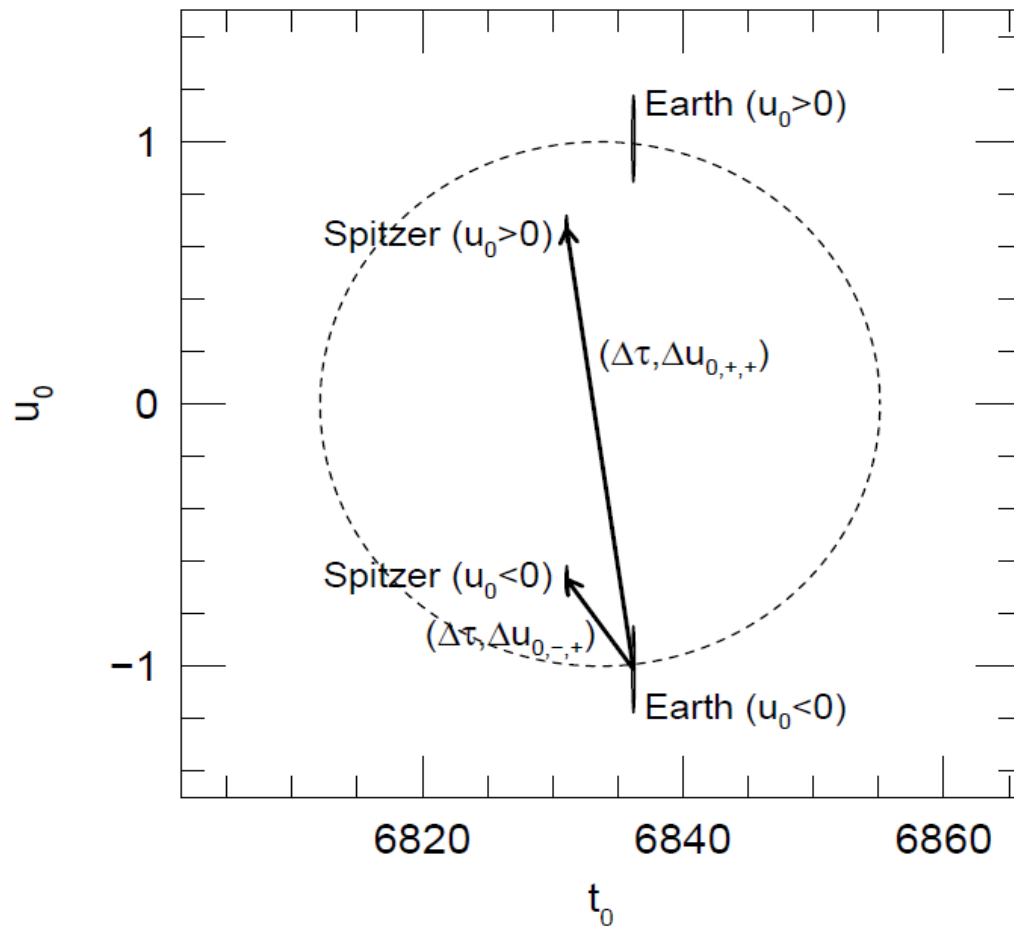

Yee et al. 2015, ApJ, 802, 76

OGLE-2014-BLG-0939:

Degeneracy Broken => Mass & Distance

$$\mu_{S,\text{hel}}(\text{N}, \text{E}) = (-0.64 \pm 0.45, -5.31 \pm 0.45) \text{ mas yr}^{-1}$$

$$\mu_{\text{exp, hel}} = \mu_{\text{sgrA*}} \phi - \mu_{S,\text{hel}} = (6.2 \pm 0.5, 8.5 \pm 0.5) \text{ mas yr}^{-1}$$

$$\tan^{-1} \frac{\mu_{\text{exp, hel, E}}}{\mu_{\text{exp, hel, N}}} = 53.9^\circ \pm 8.5^\circ$$

$$\pi_{\text{rel}} \sim \mu_{\text{exp, hel}} \frac{\text{AU}}{\tilde{v}_{\text{hel}}} = 0.20 \text{ mas}$$

$$M = \frac{\pi_{\text{rel}}}{\kappa \pi_{\text{E}}^2} \sim 0.23 M_{\odot}$$

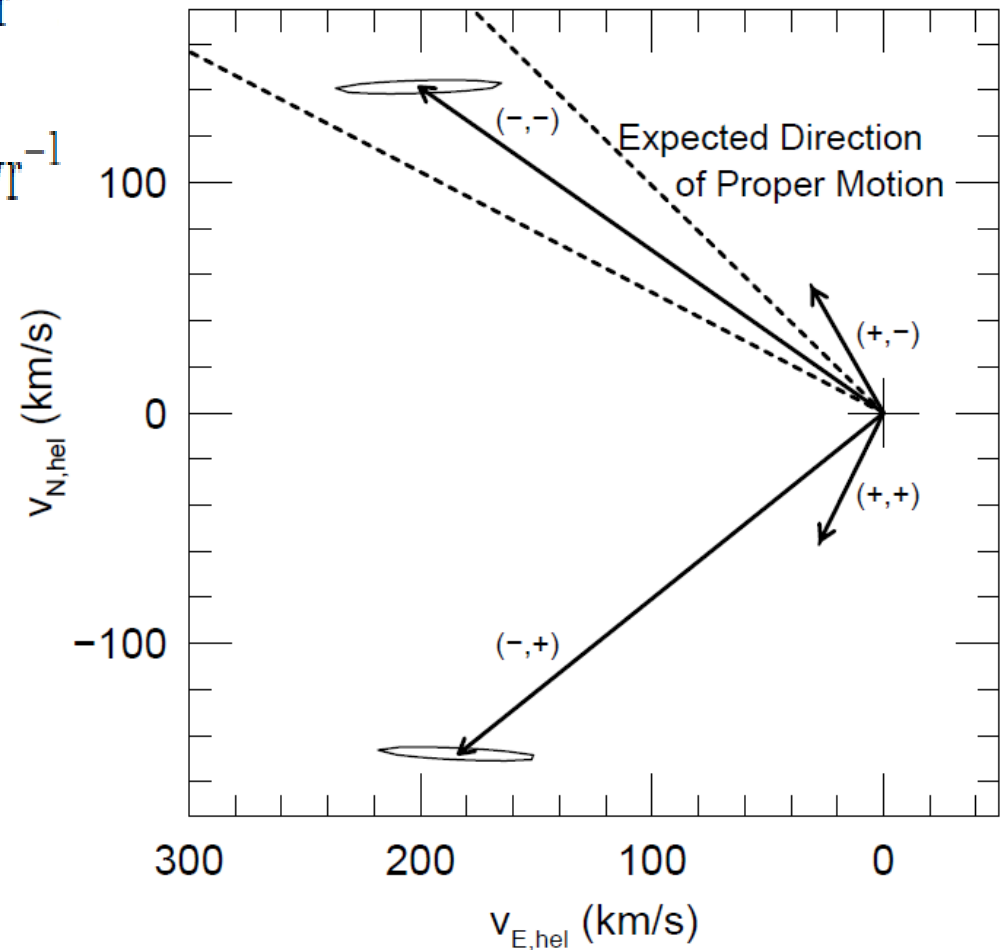

Yee et al. 2015, ApJ, 802, 76

OGLE-2014-BLG-0124:

First Microlens Planet with Spitzer Parallax

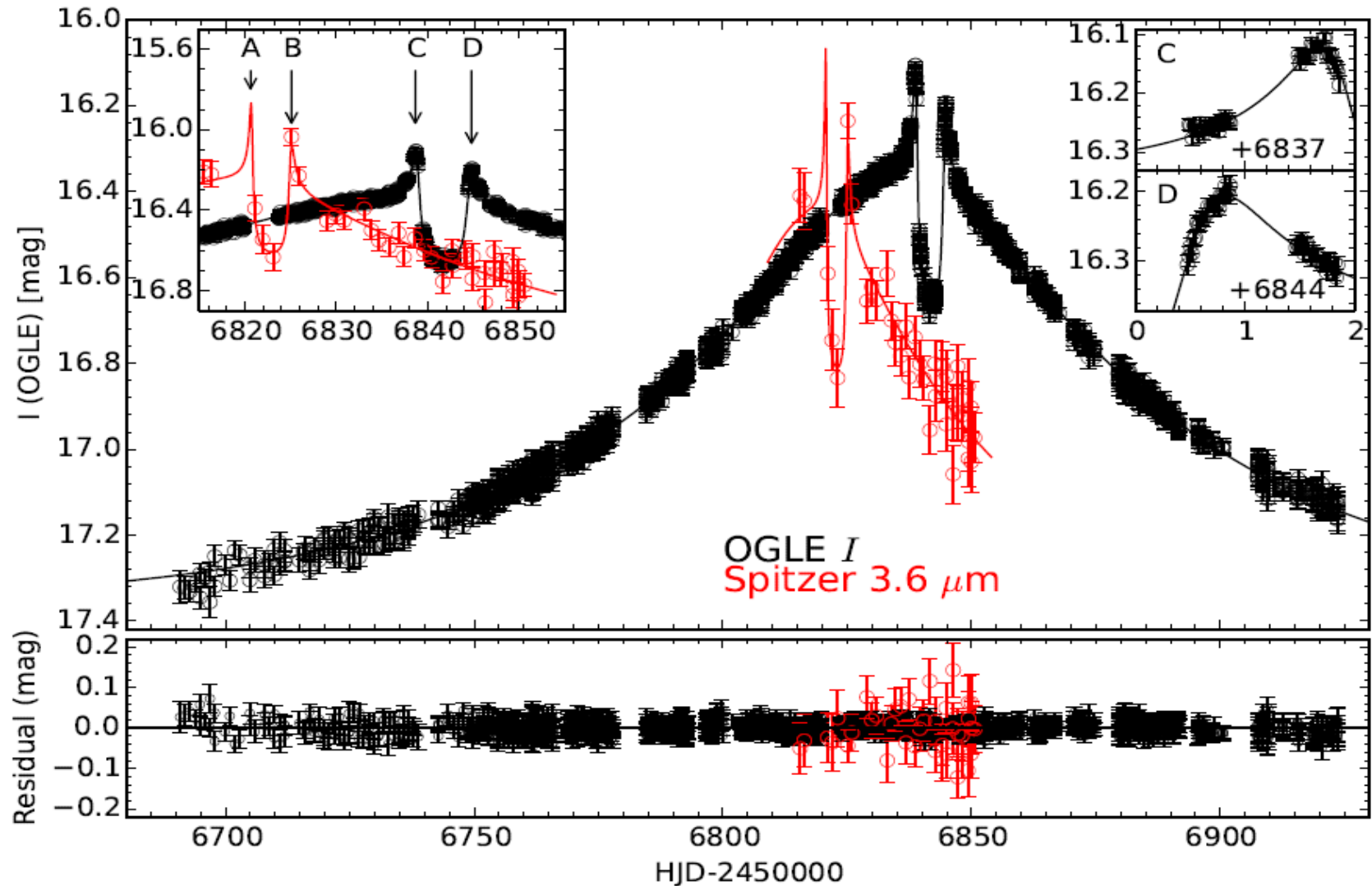

Udalski et al. 2015, ApJ, 799, 237

OGLE-2014-BLG-0124:

How Spitzer Observations Were Chosen

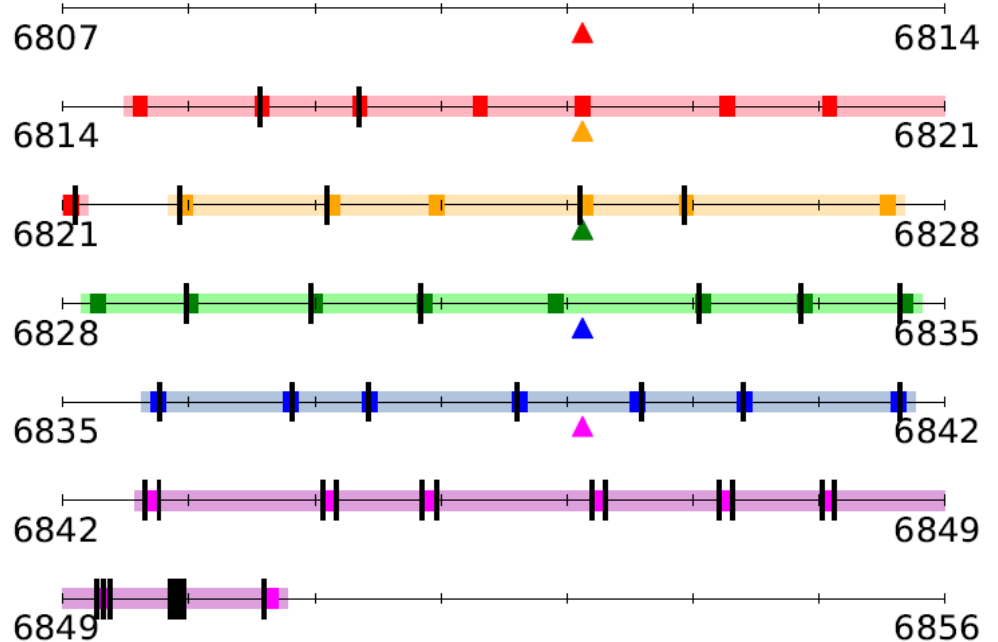
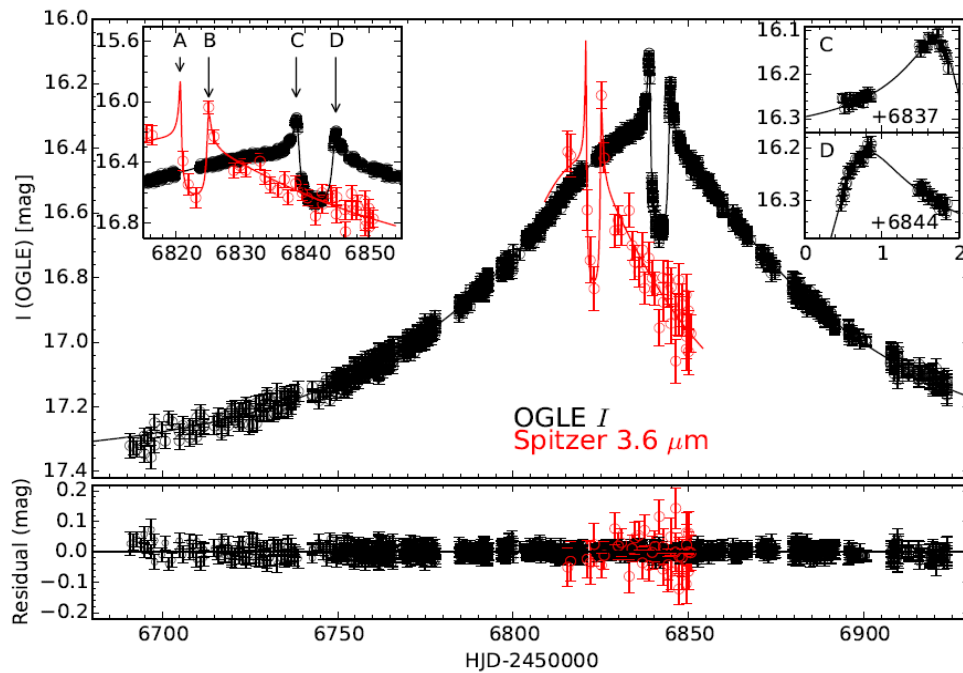

Udalski et al. 2015, ApJ, 799, 237

OGLE-2014-BLG-0124: The “Big Dip”

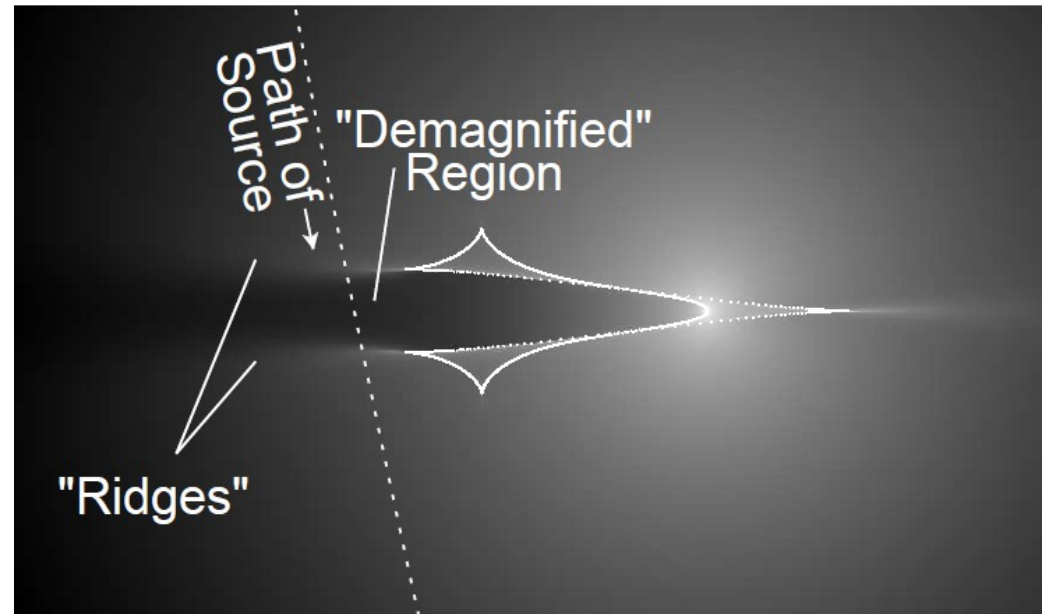
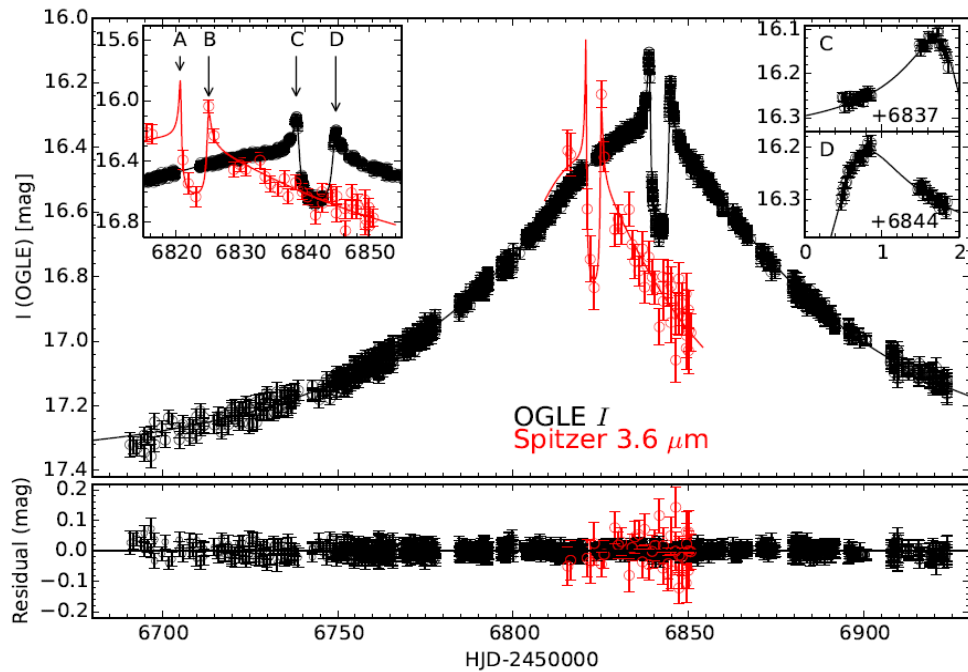

Udalski et al. 2015, ApJ, 799, 237

OGLE-2014-BLG-0124: Source and Caustic Reconstruction

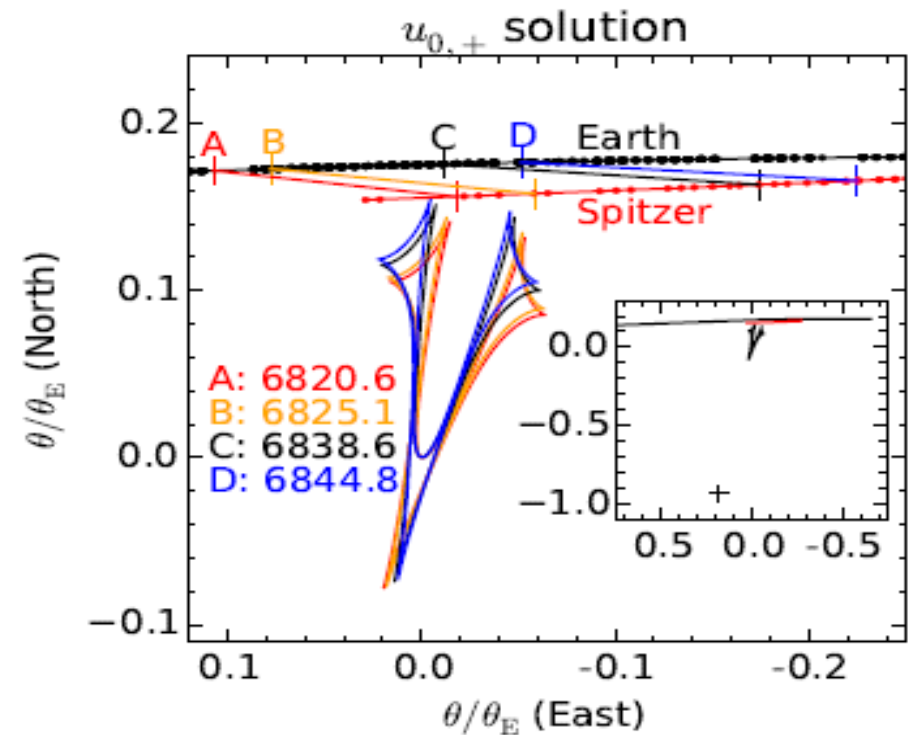
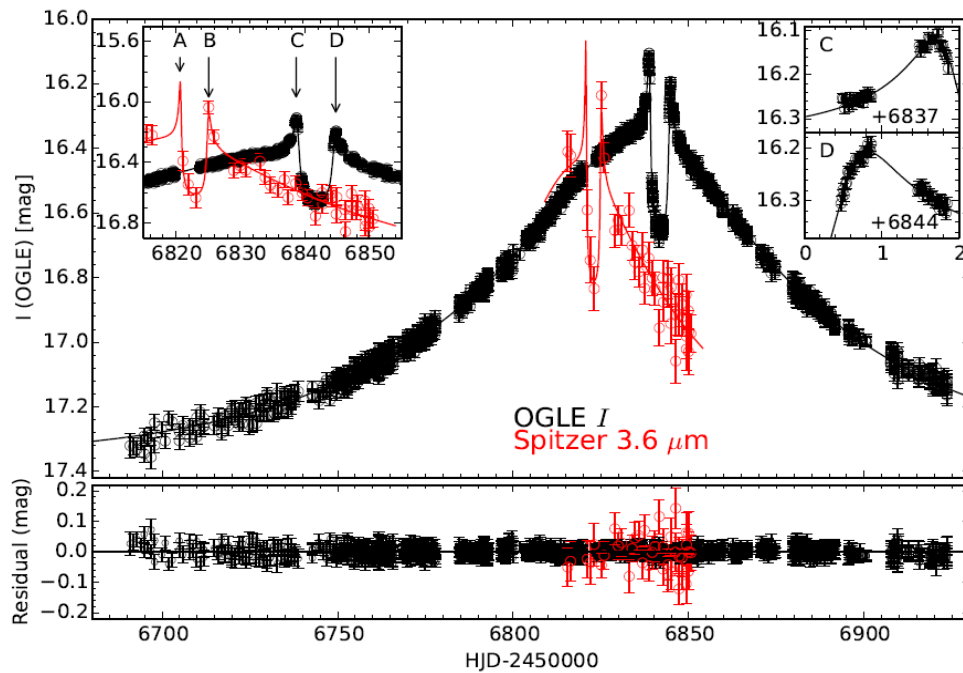

Udalski et al. 2015, ApJ, 799, 237

OGLE-2014-BLG-0124: Source and Caustic Reconstruction

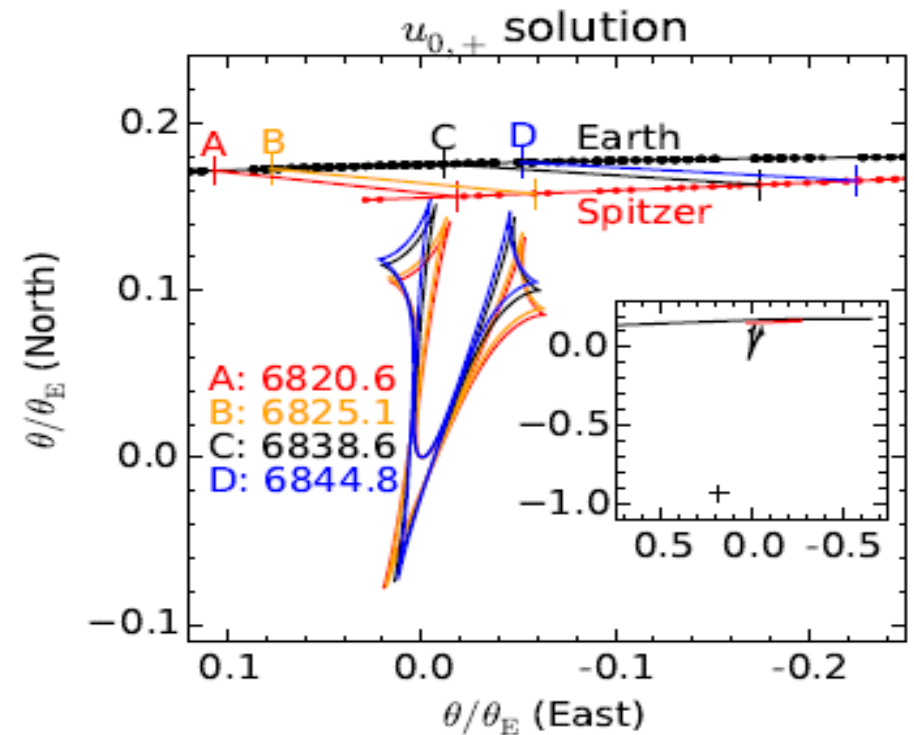
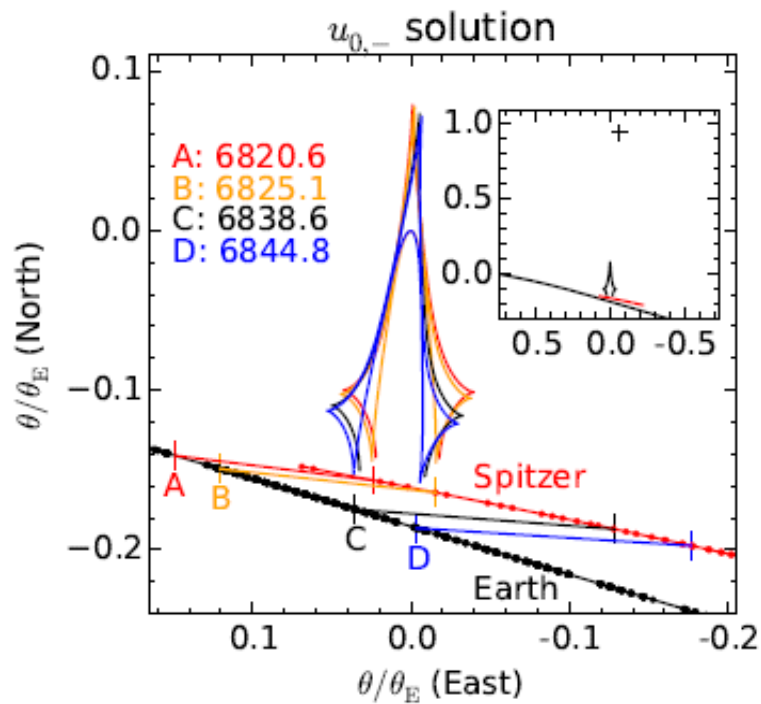

Udalski et al. 2015, ApJ, 799, 237

22 Point-Lens Spitzer Parallax Measurements

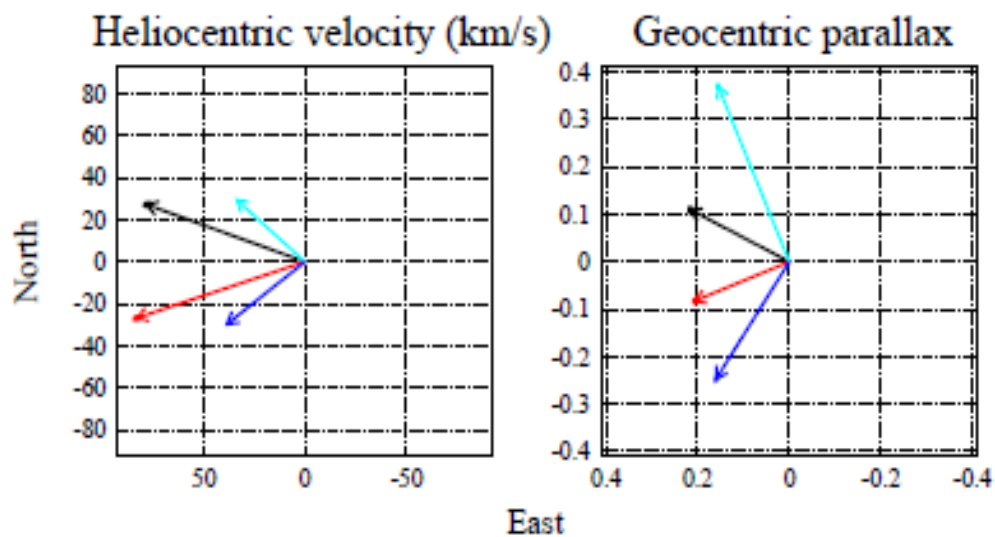
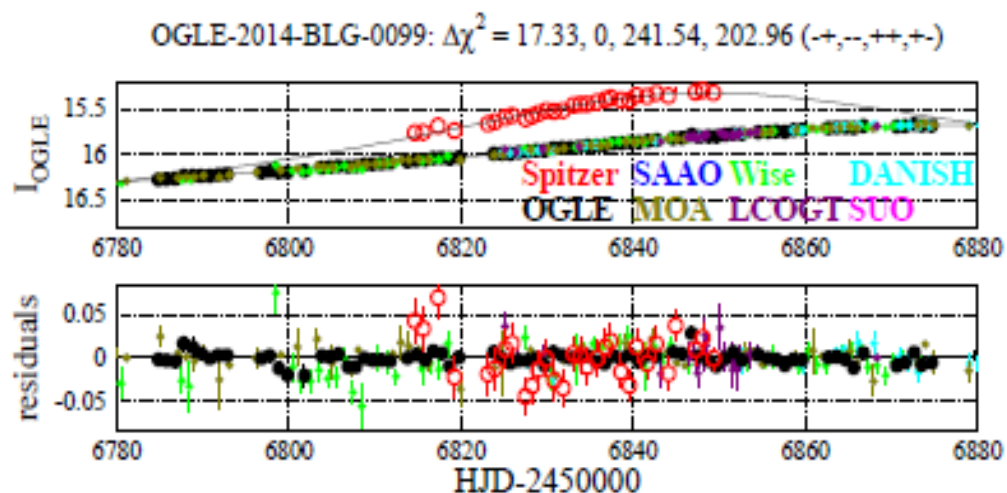

Calchi Novati et al. 2014, ApJ, in press

22 Point-Lens Spitzer Parallax Measurements

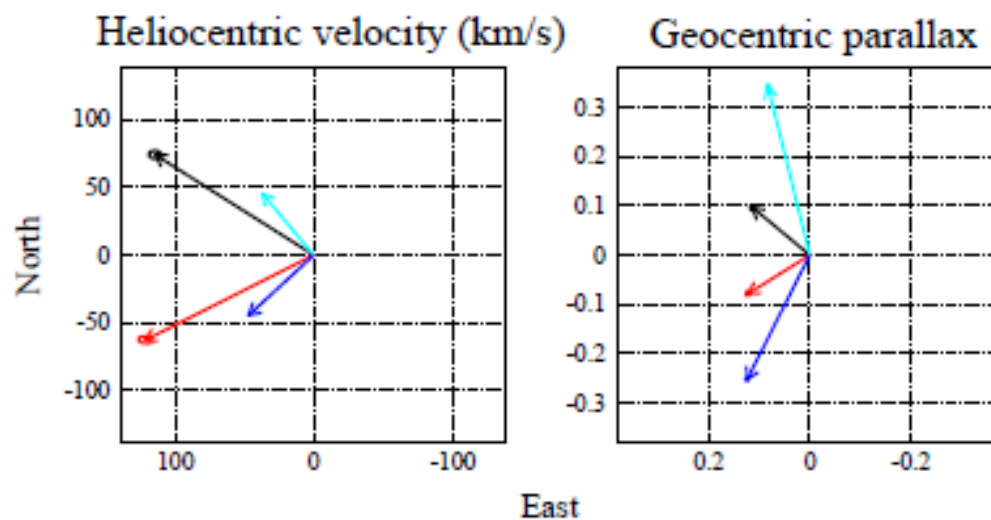
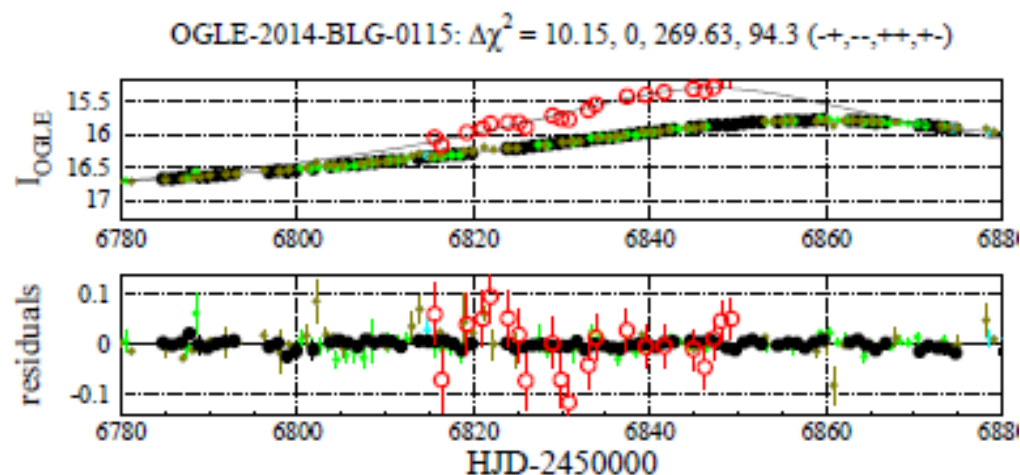

Calchi Novati et al. 2014, ApJ, in press

22 Point-Lens Spitzer Parallax Measurements

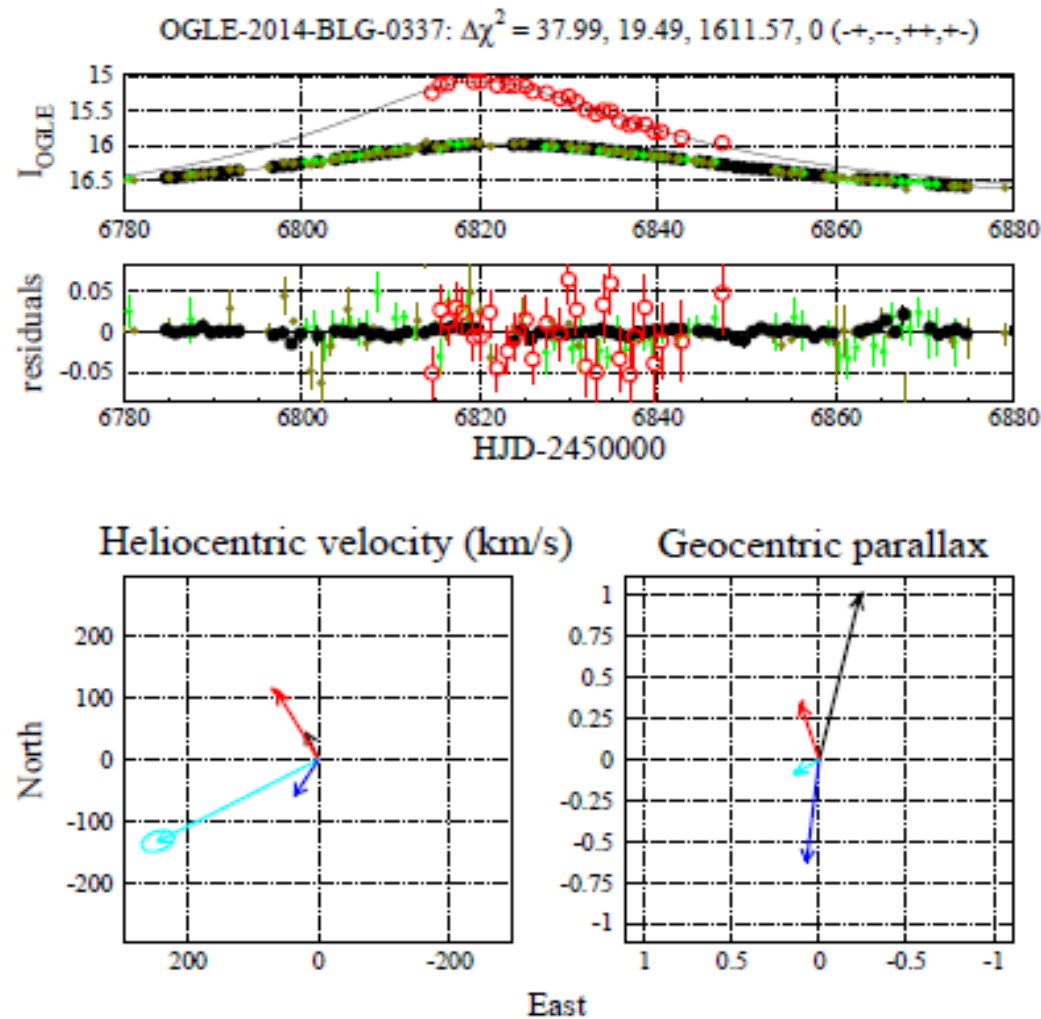

Calchi Novati et al. 2014, ApJ, in press

22 Point-Lens Spitzer Parallax Measurements

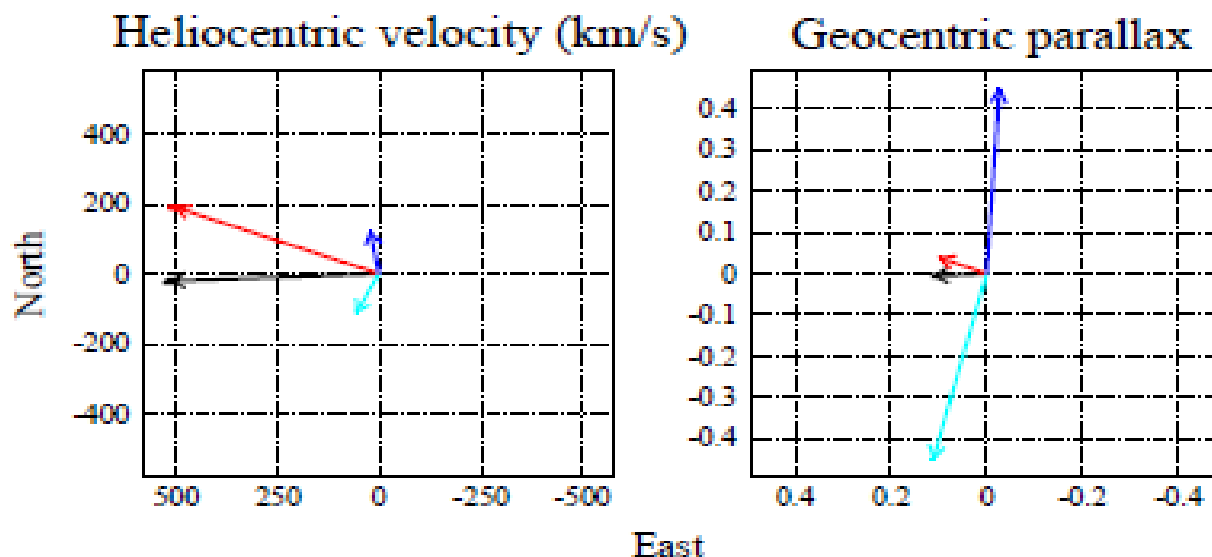
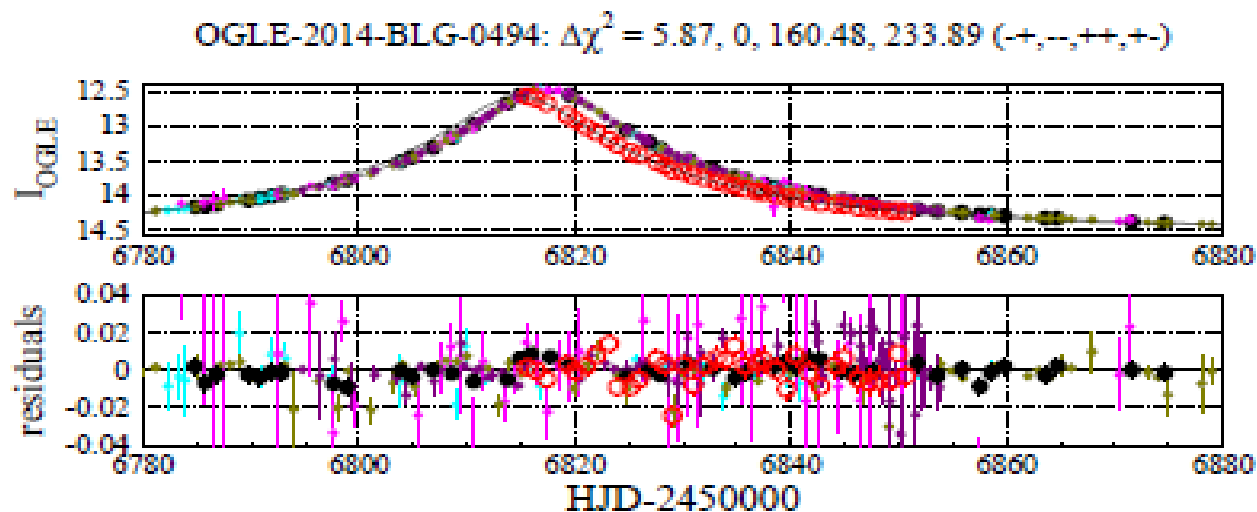

Calchi Novati et al. 2014, ApJ, in press

22 Point-Lens Spitzer Parallax Measurements

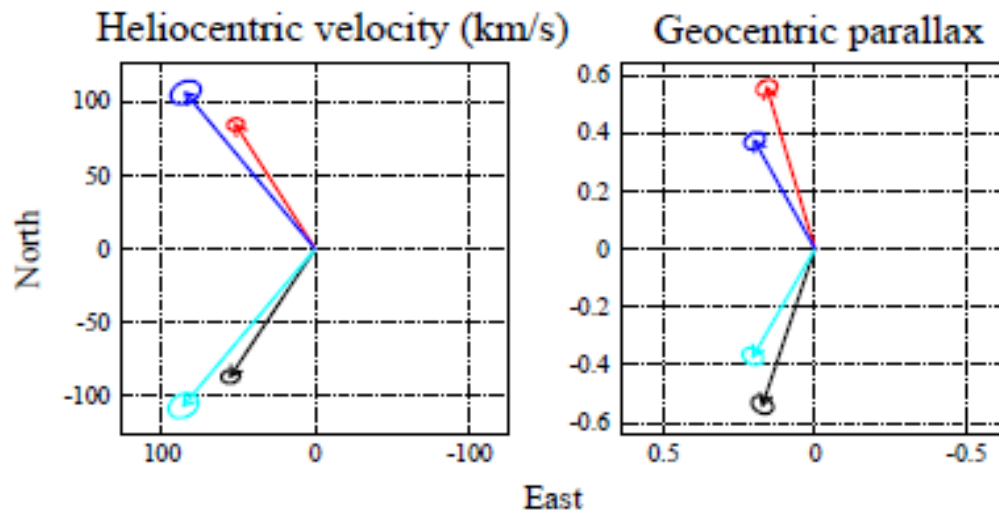
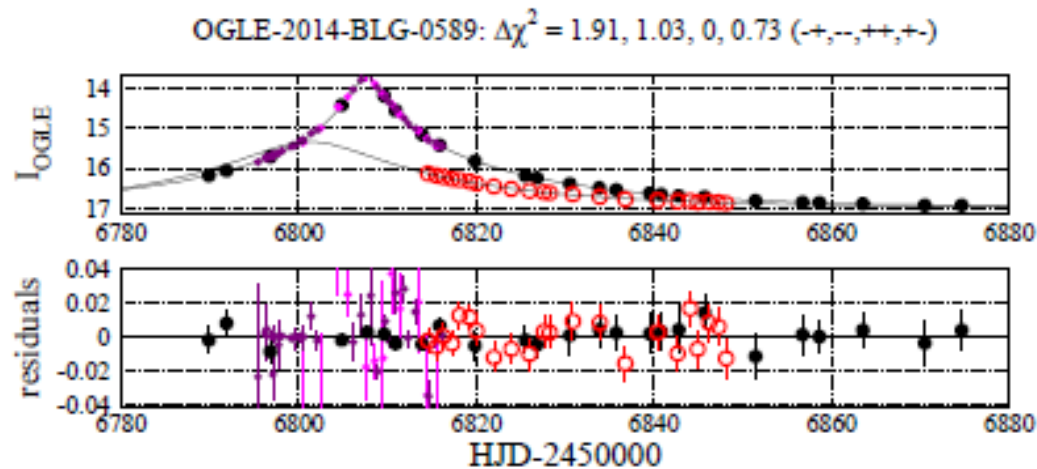

Calchi Novati et al. 2014, ApJ, in press

22 Point-Lens Spitzer Parallax Measurements

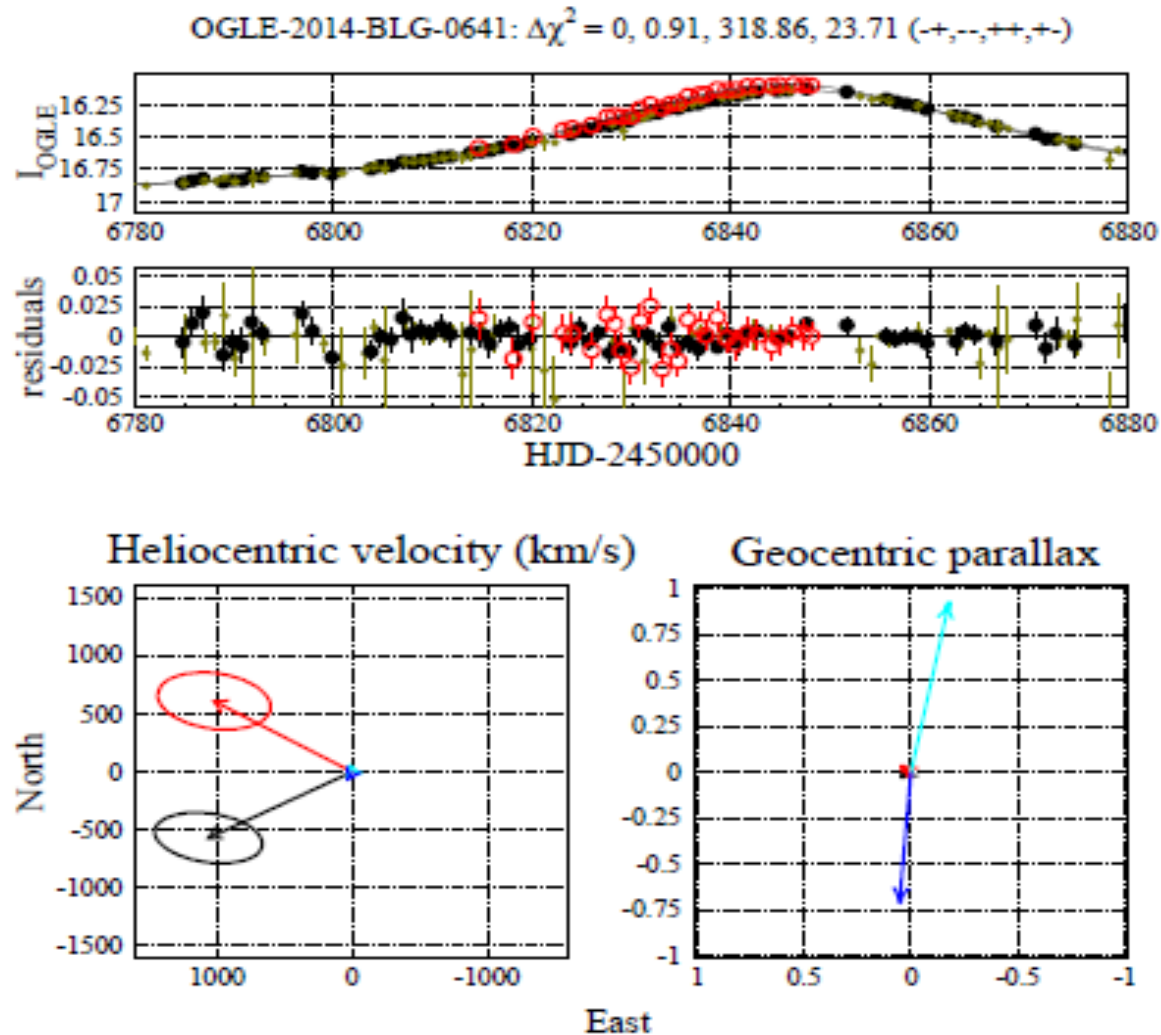

Calchi Novati et al. 2014, ApJ, in press

22 Point-Lens Spitzer Parallax Measurements

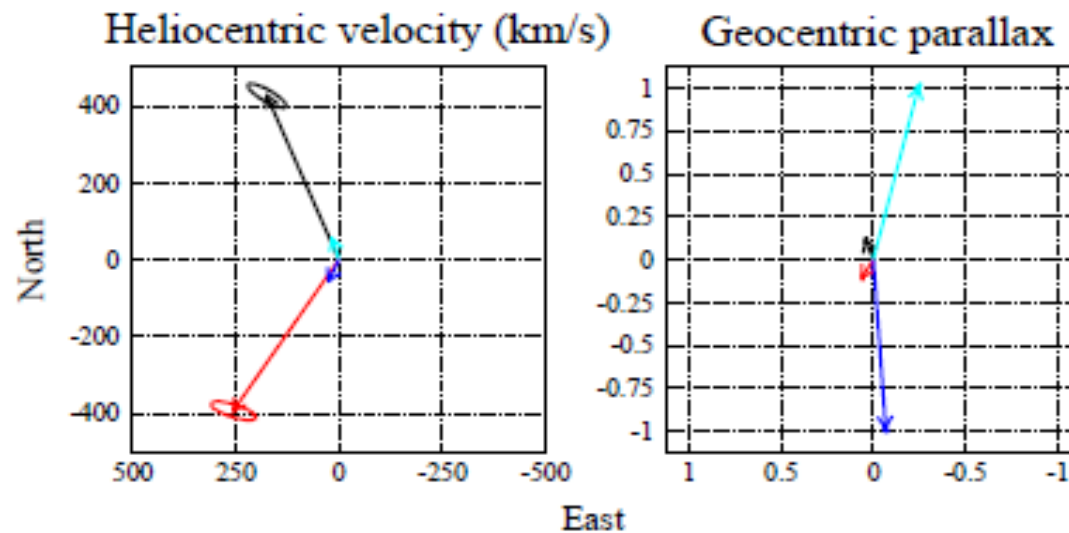
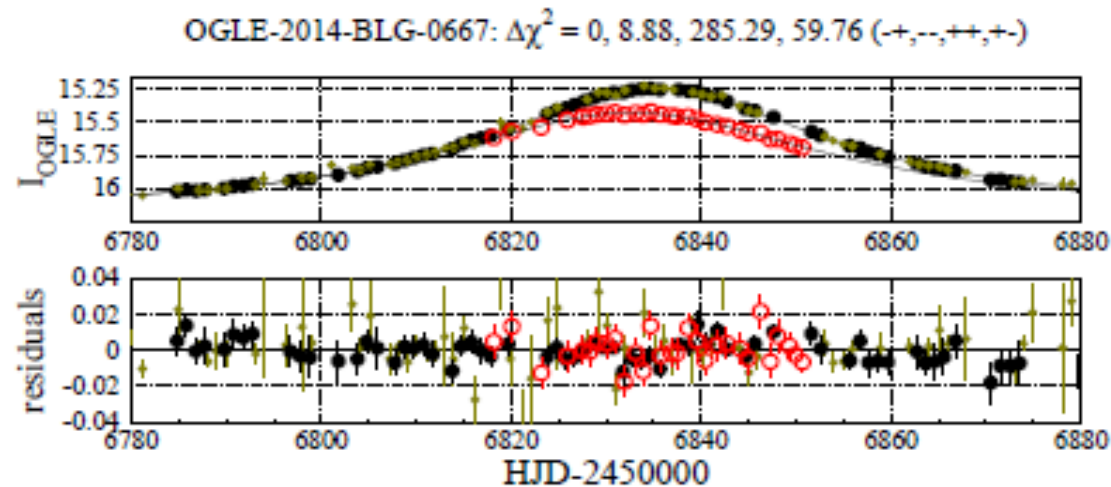

Calchi Novati et al. 2014, ApJ, in press

22 Point-Lens Spitzer Parallax Measurements

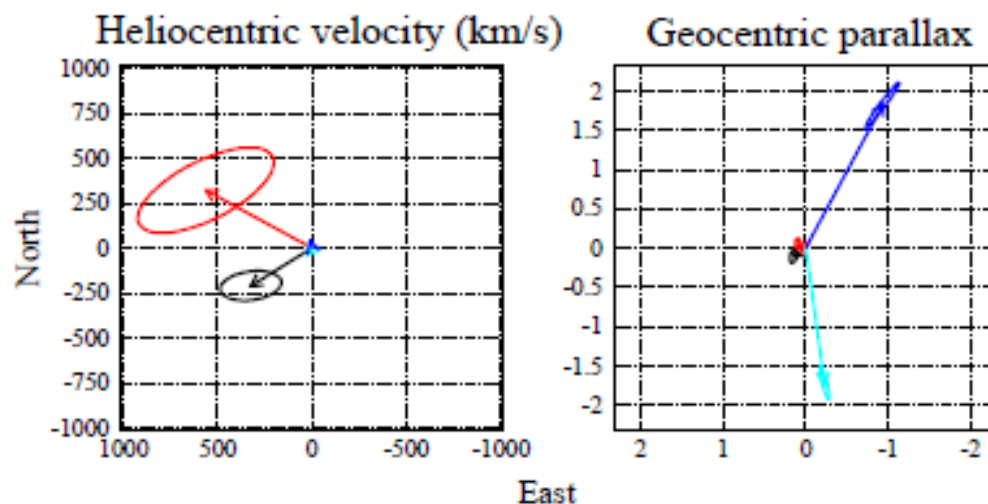
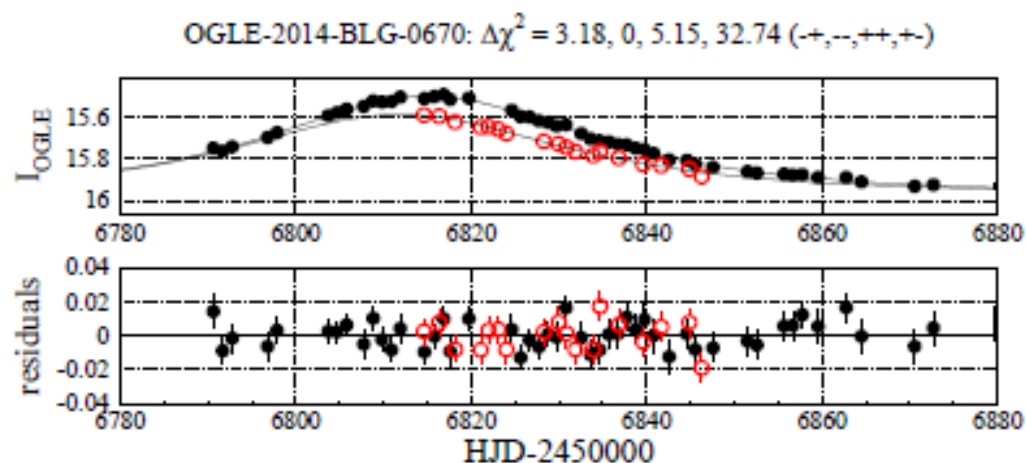

Calchi Novati et al. 2014, ApJ, in press

22 Point-Lens Spitzer Parallax Measurements

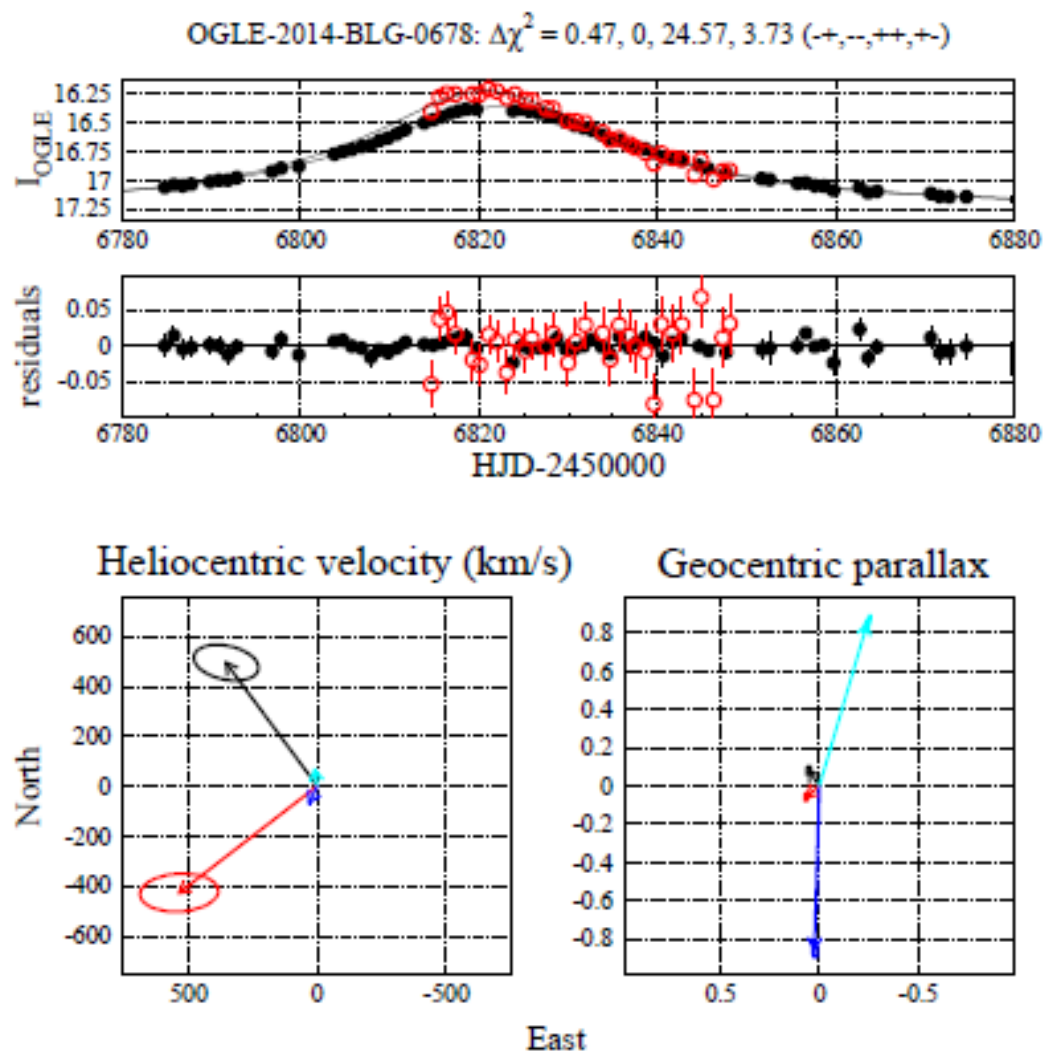

Calchi Novati et al. 2014, ApJ, in press

22 Point-Lens Spitzer Parallax Measurements

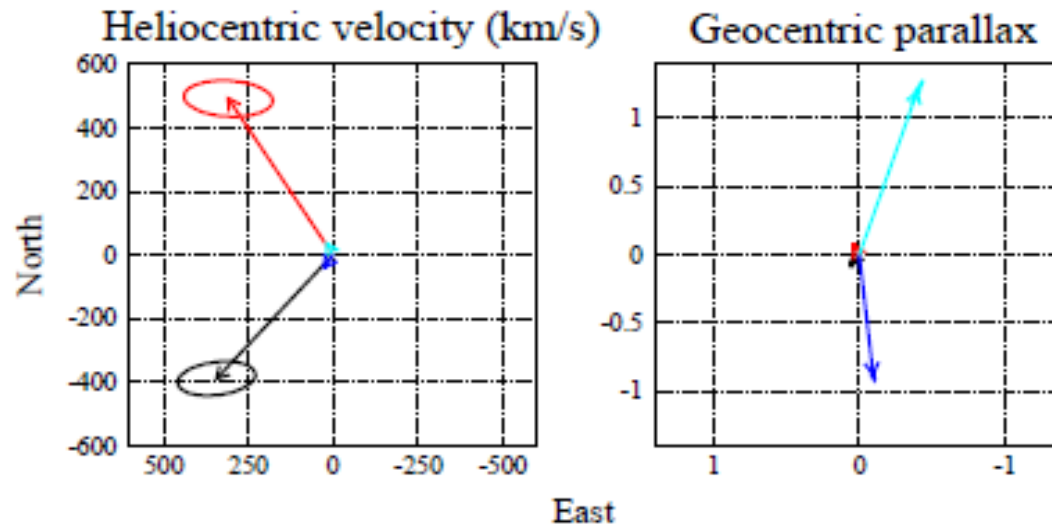
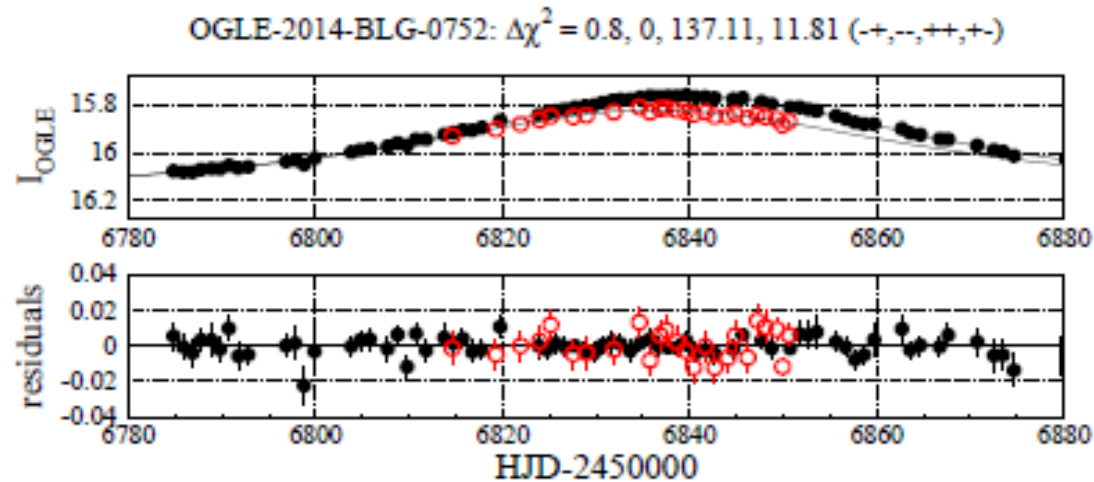

Calchi Novati et al. 2014, ApJ, in press

22 Point-Lens Spitzer Parallax Measurements

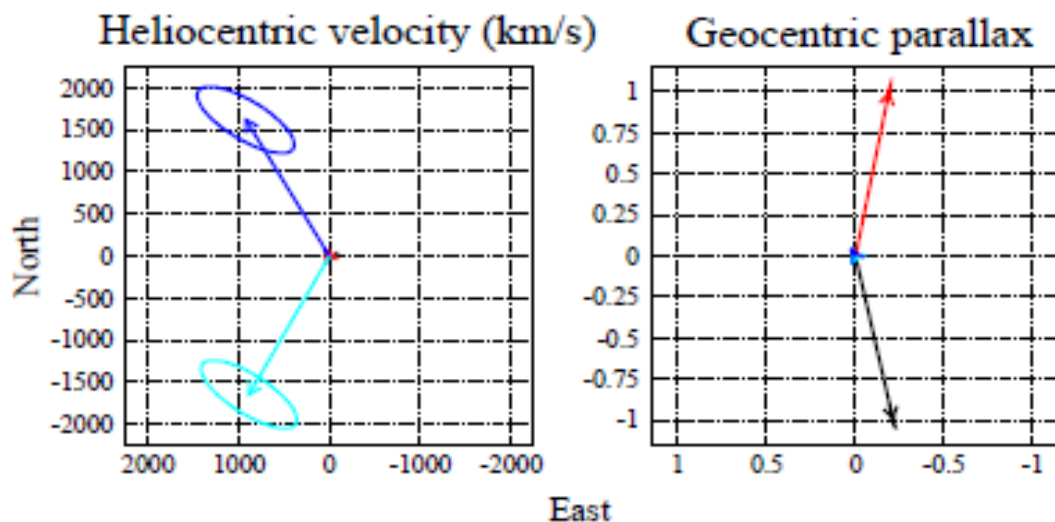
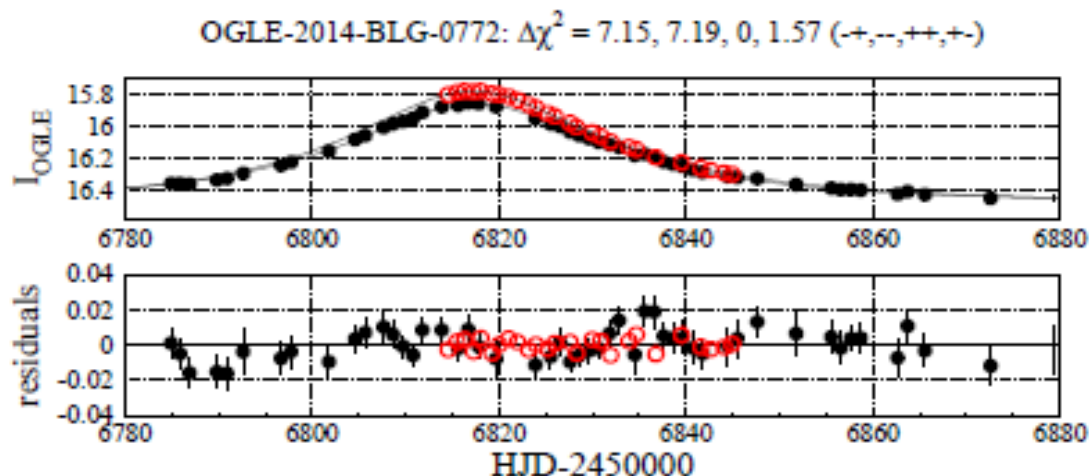

Calchi Novati et al. 2014, ApJ, in press

22 Point-Lens Spitzer Parallax Measurements

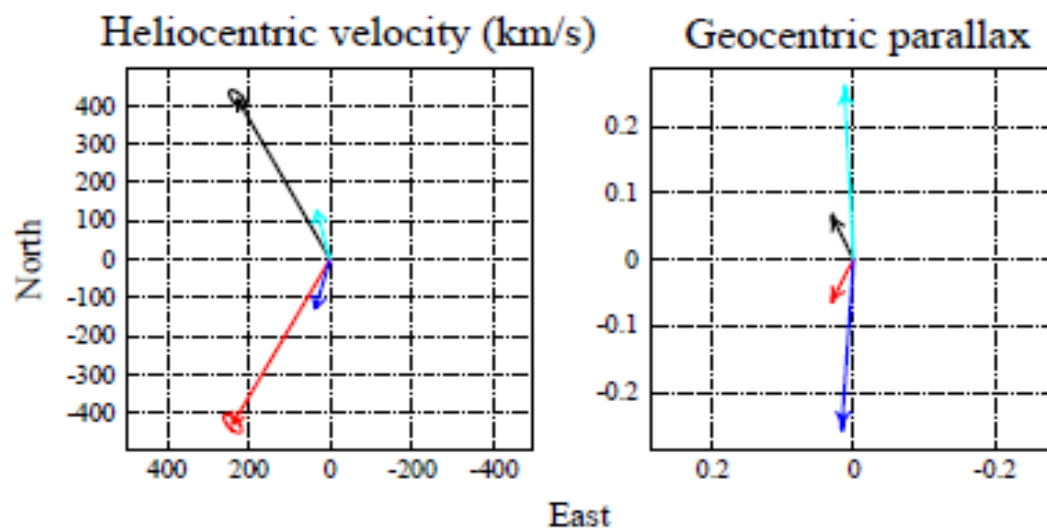
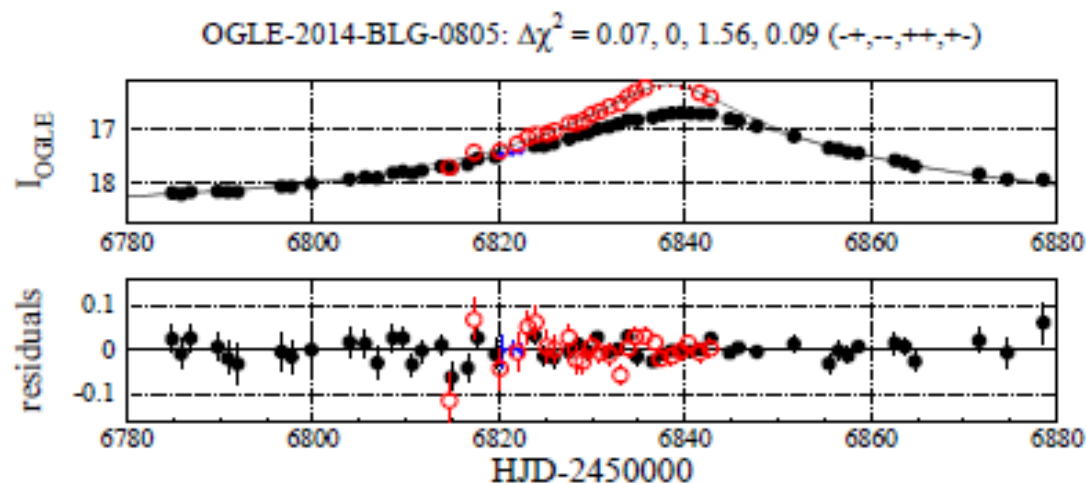

Calchi Novati et al. 2014, ApJ, in press

22 Point-Lens Spitzer Parallax Measurements

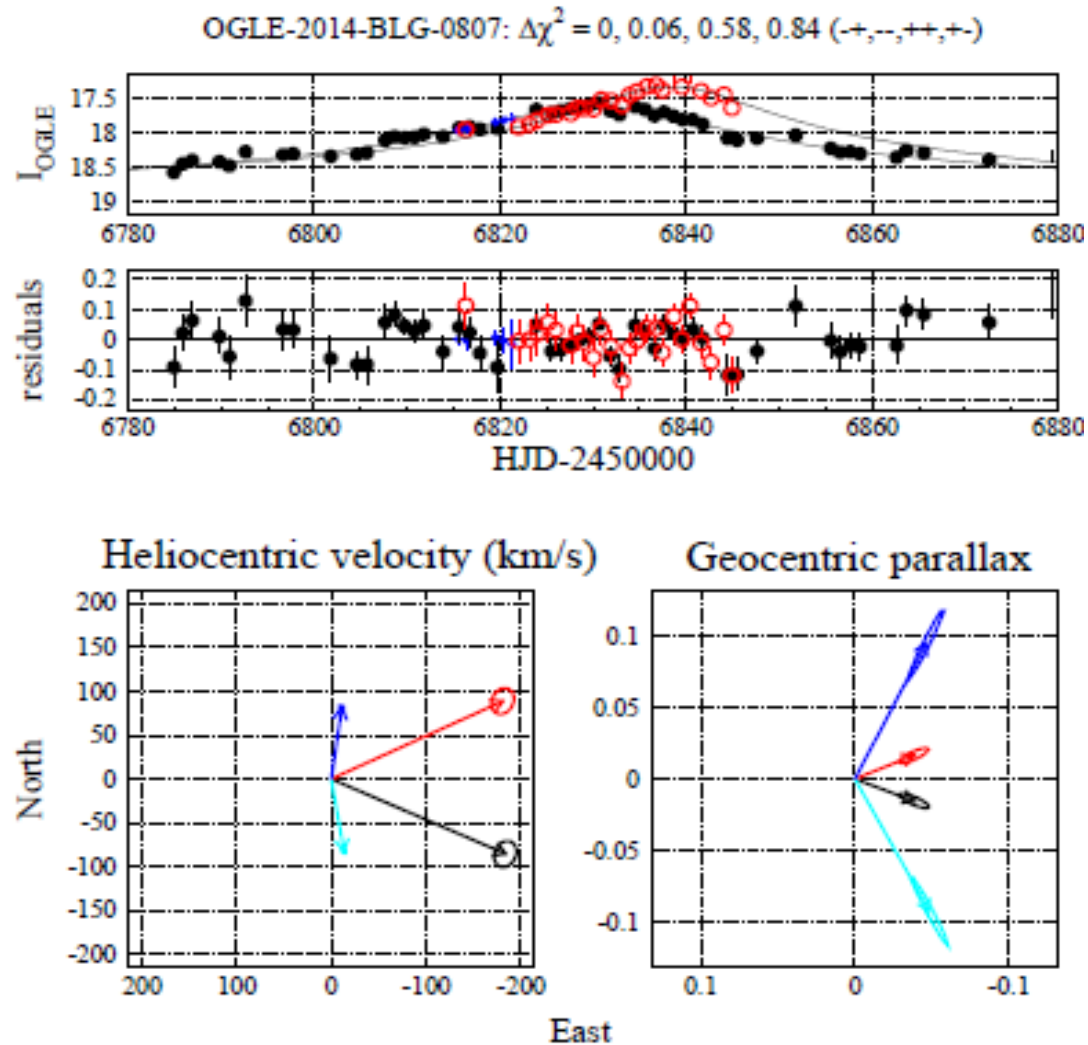

Calchi Novati et al. 2014, ApJ, in press

22 Point-Lens Spitzer Parallax Measurements

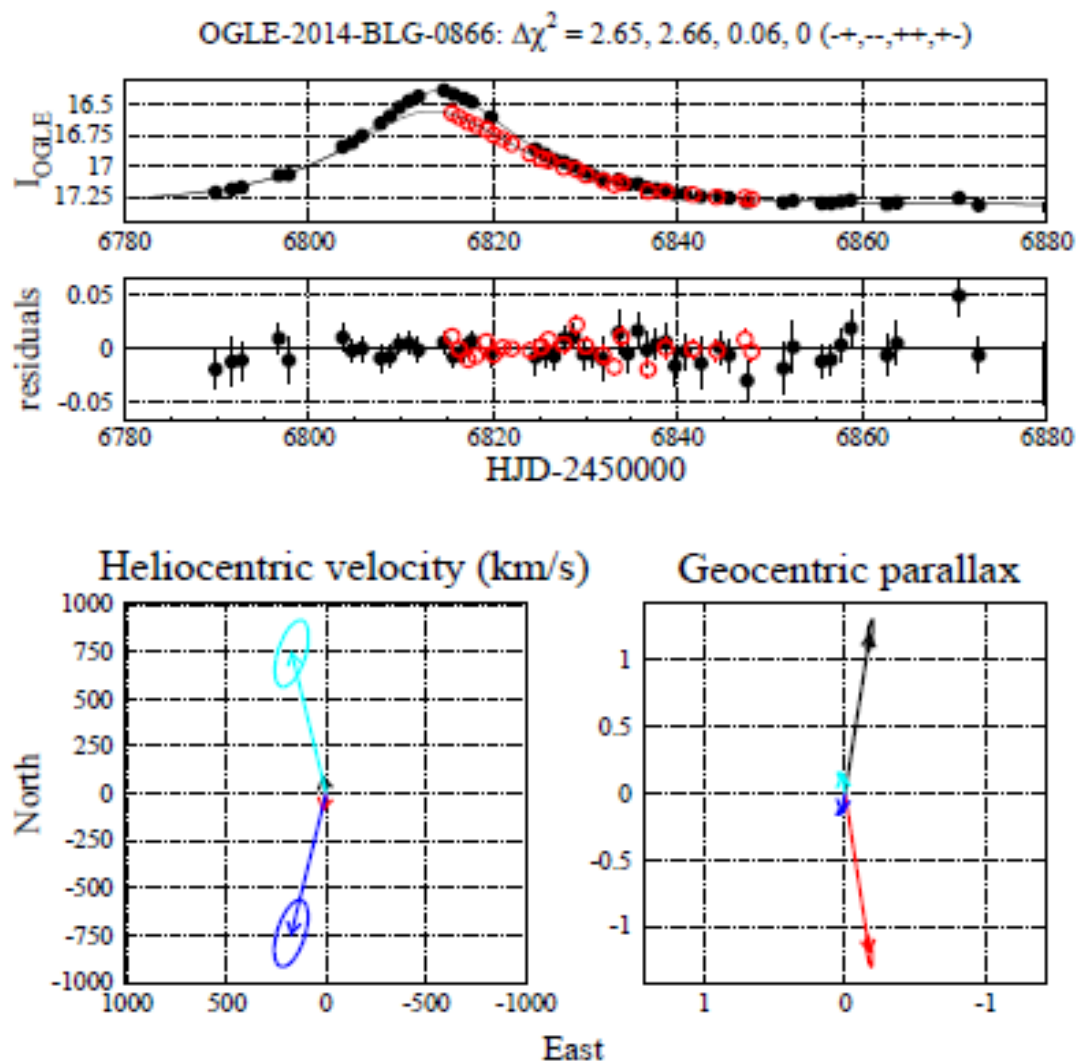

Calchi Novati et al. 2014, ApJ, in press

22 Point-Lens Spitzer Parallax Measurements

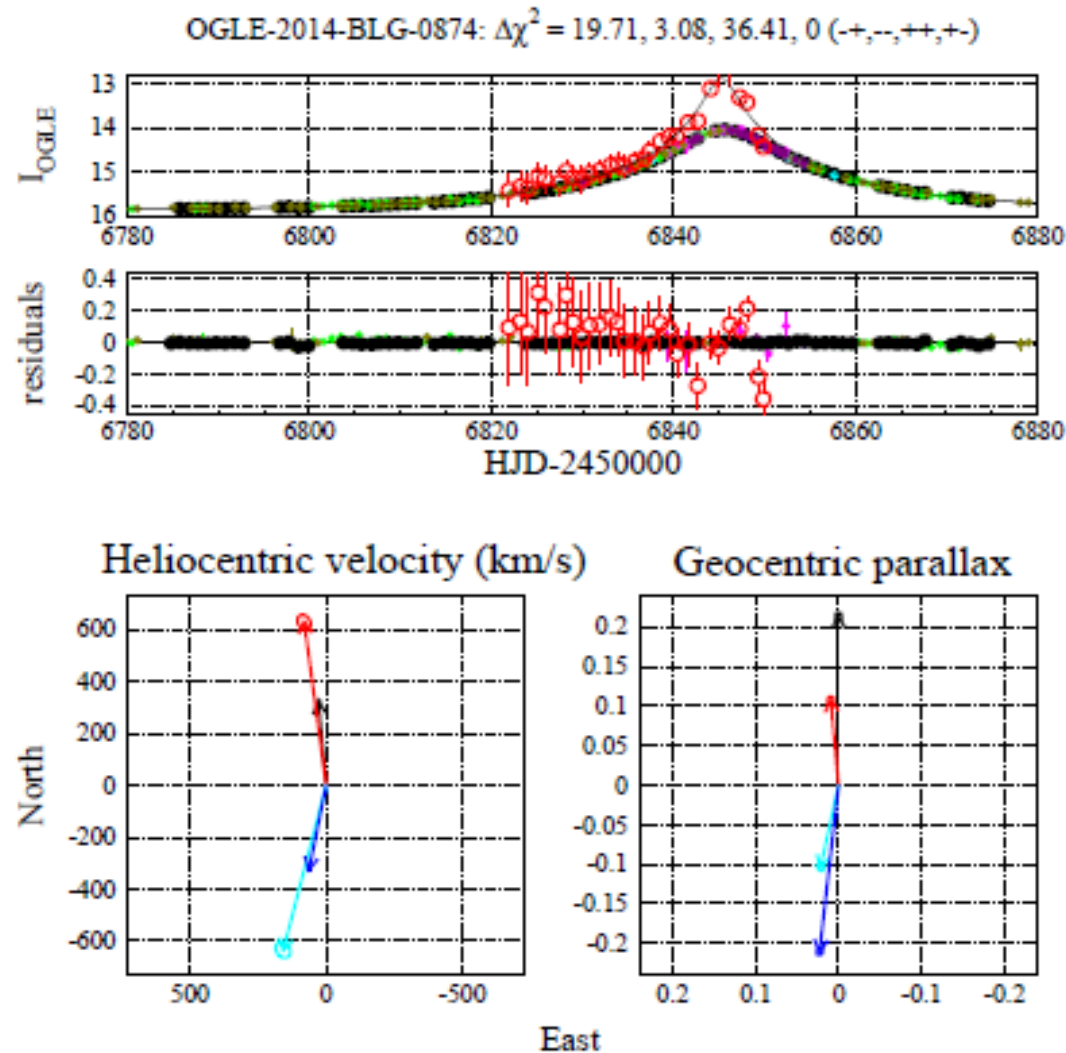

Calchi Novati et al. 2014, ApJ, in press

22 Point-Lens Spitzer Parallax Measurements

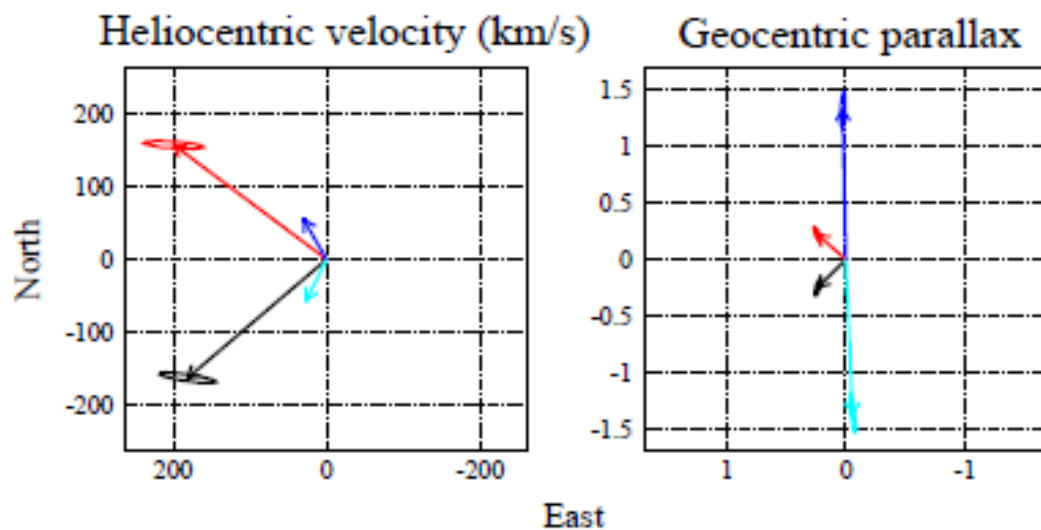
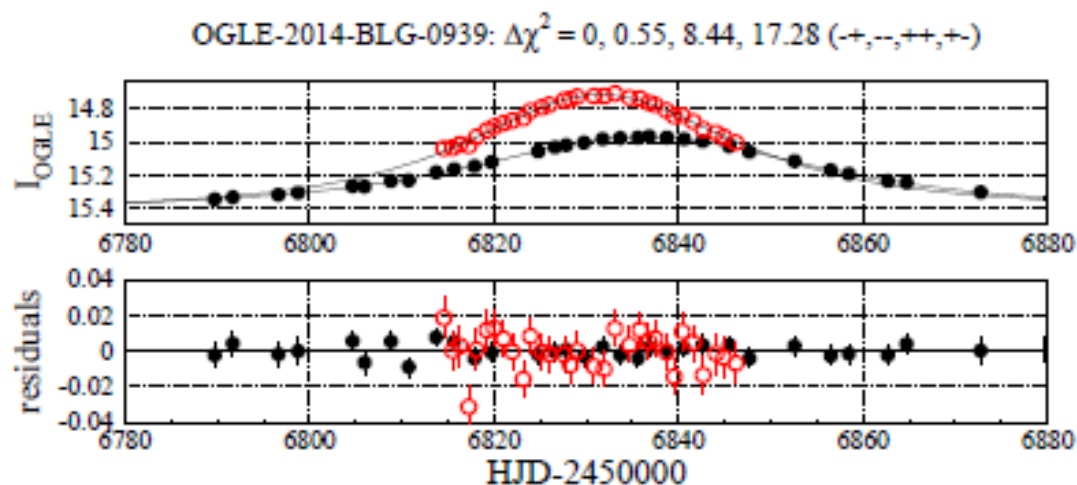

Calchi Novati et al. 2014, ApJ, in press

22 Point-Lens Spitzer Parallax Measurements

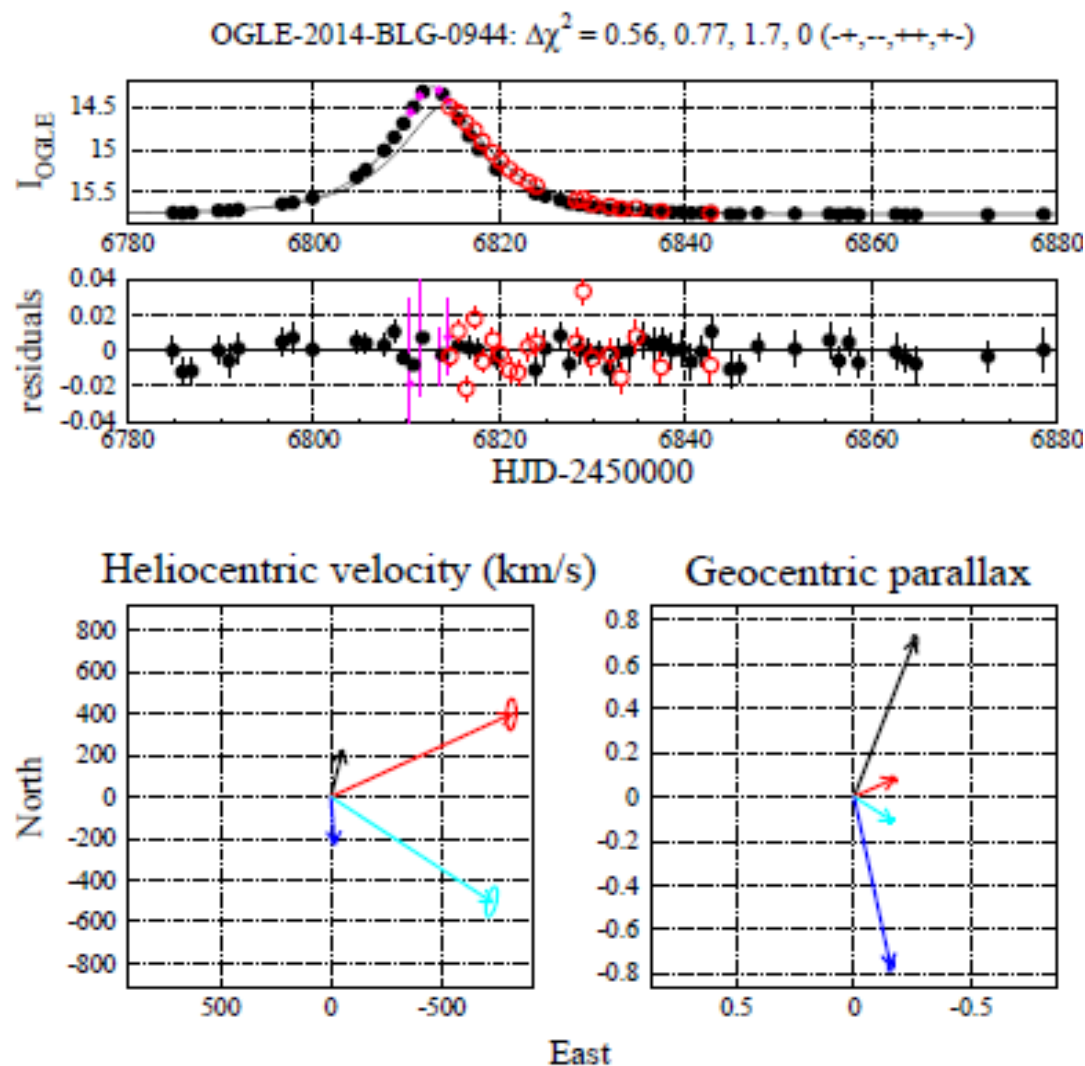

Calchi Novati et al. 2014, ApJ, in press

22 Point-Lens Spitzer Parallax Measurements

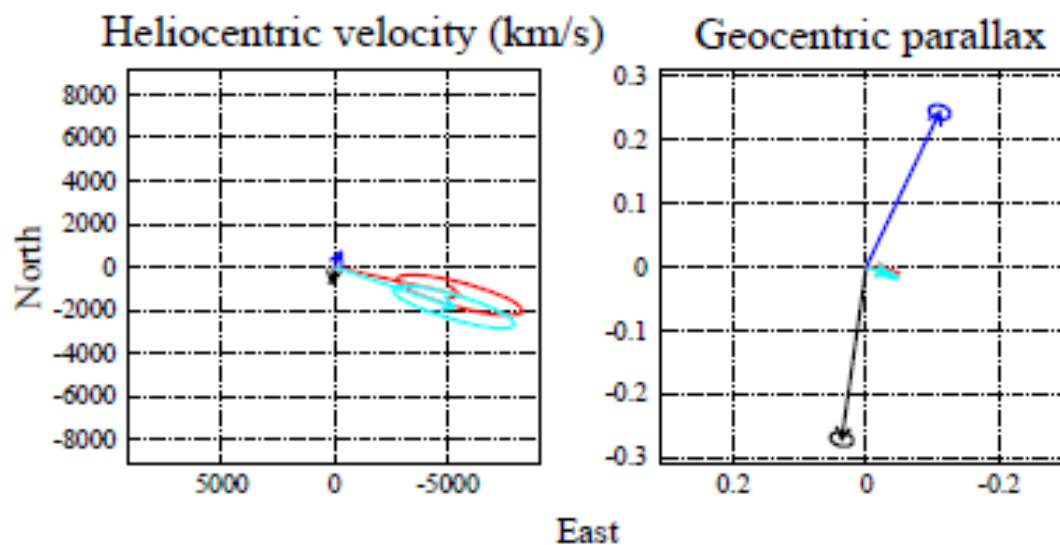
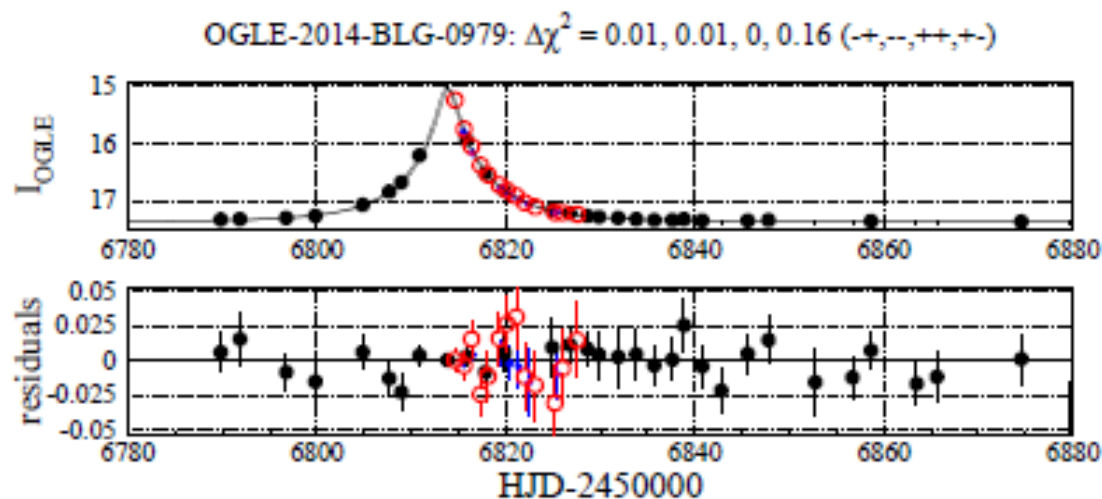

Calchi Novati et al. 2014, ApJ, in press

22 Point-Lens Spitzer Parallax Measurements

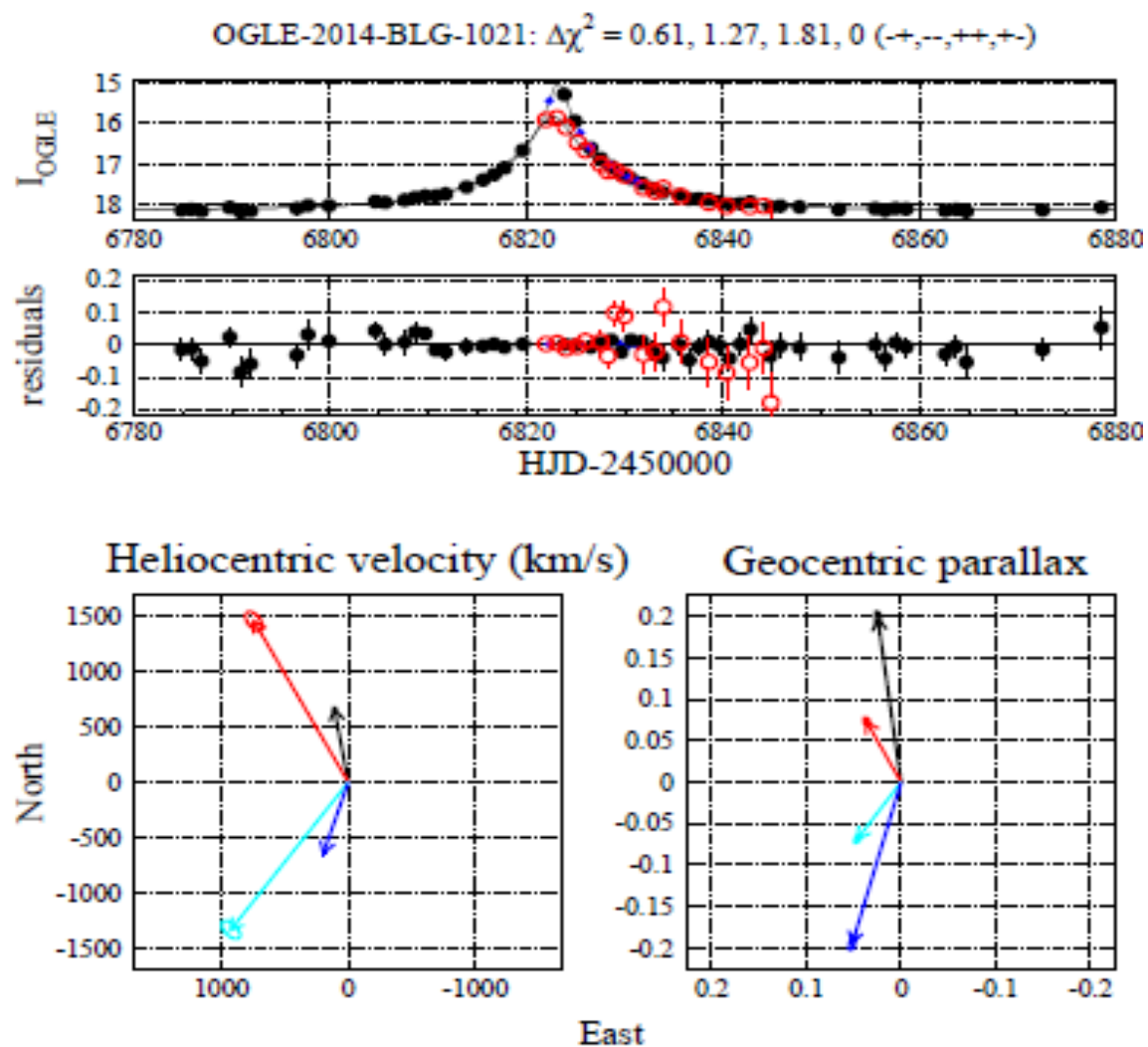

Calchi Novati et al. 2014, ApJ, in press

22 Point-Lens Spitzer Parallax Measurements

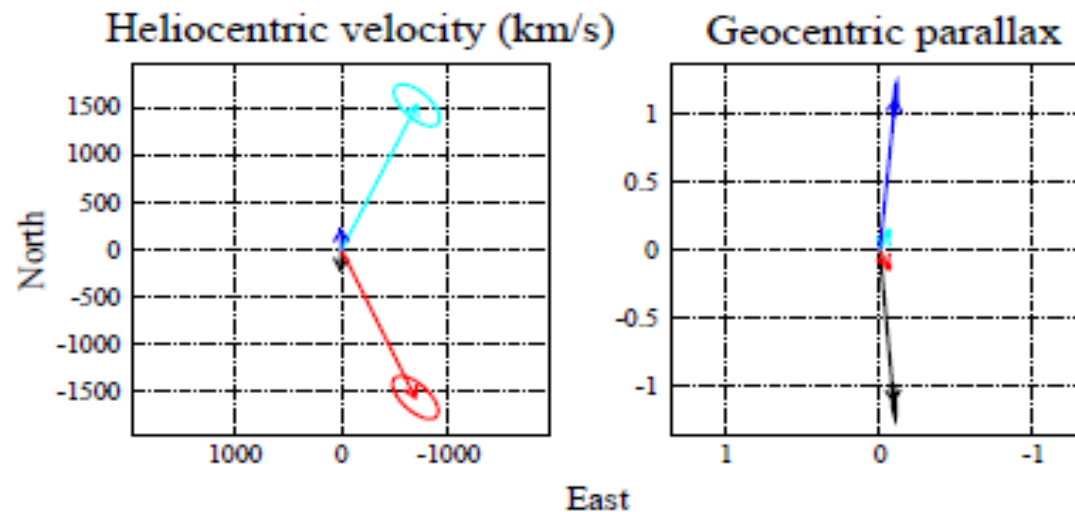
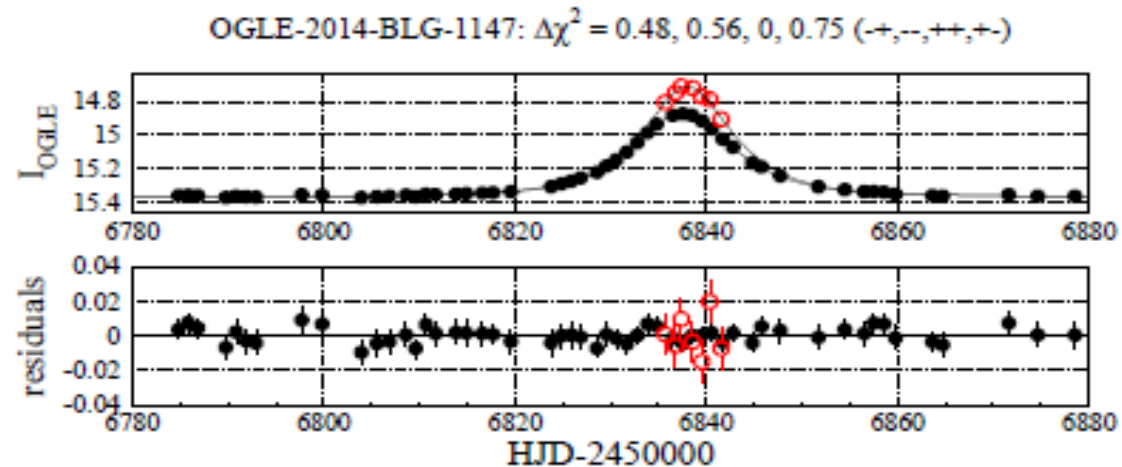

Calchi Novati et al. 2014, ApJ, in press

22 Point-Lens Spitzer Parallax Measurements

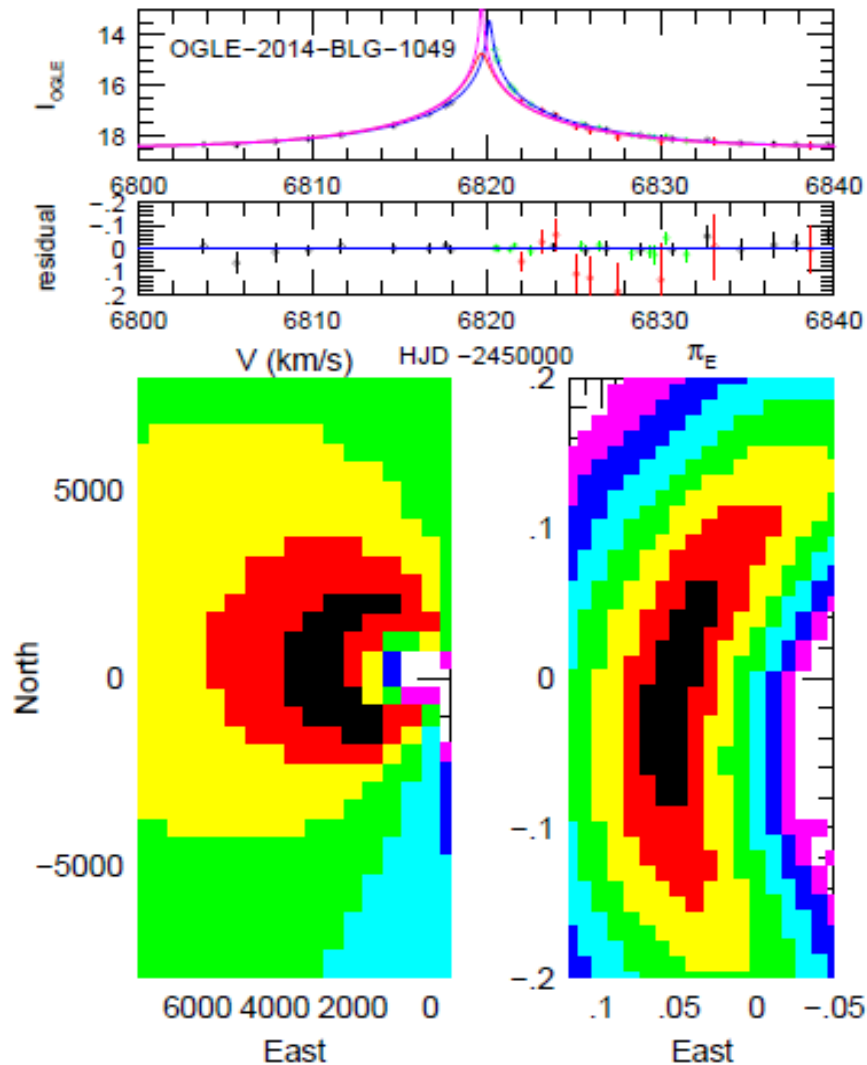

Calchi Novati et al. 2014, ApJ, in press

22 Point-Lens Spitzer Parallax Measurements Versus 1 Planet

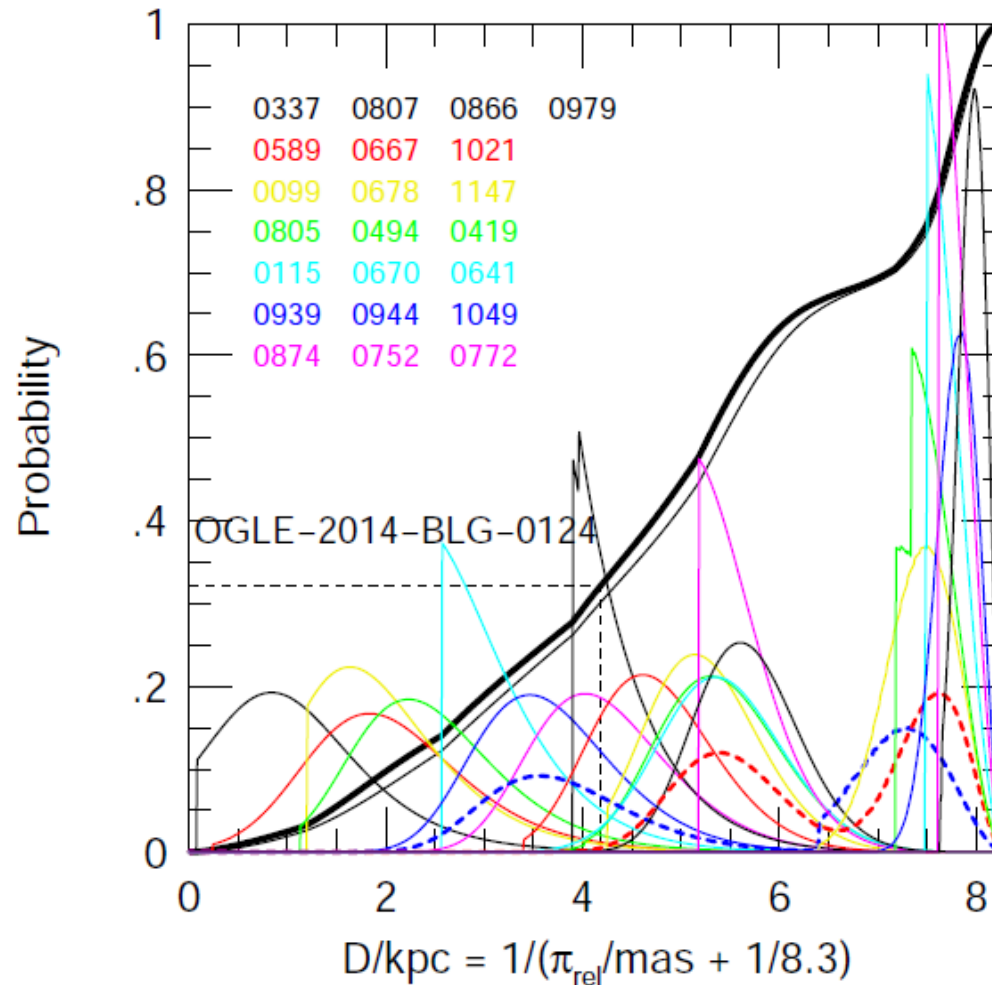

Calchi Novati et al. 2014, ApJ, in press

OGLE-2014-BLG-1050: First Binary Caustic Crossing From Space

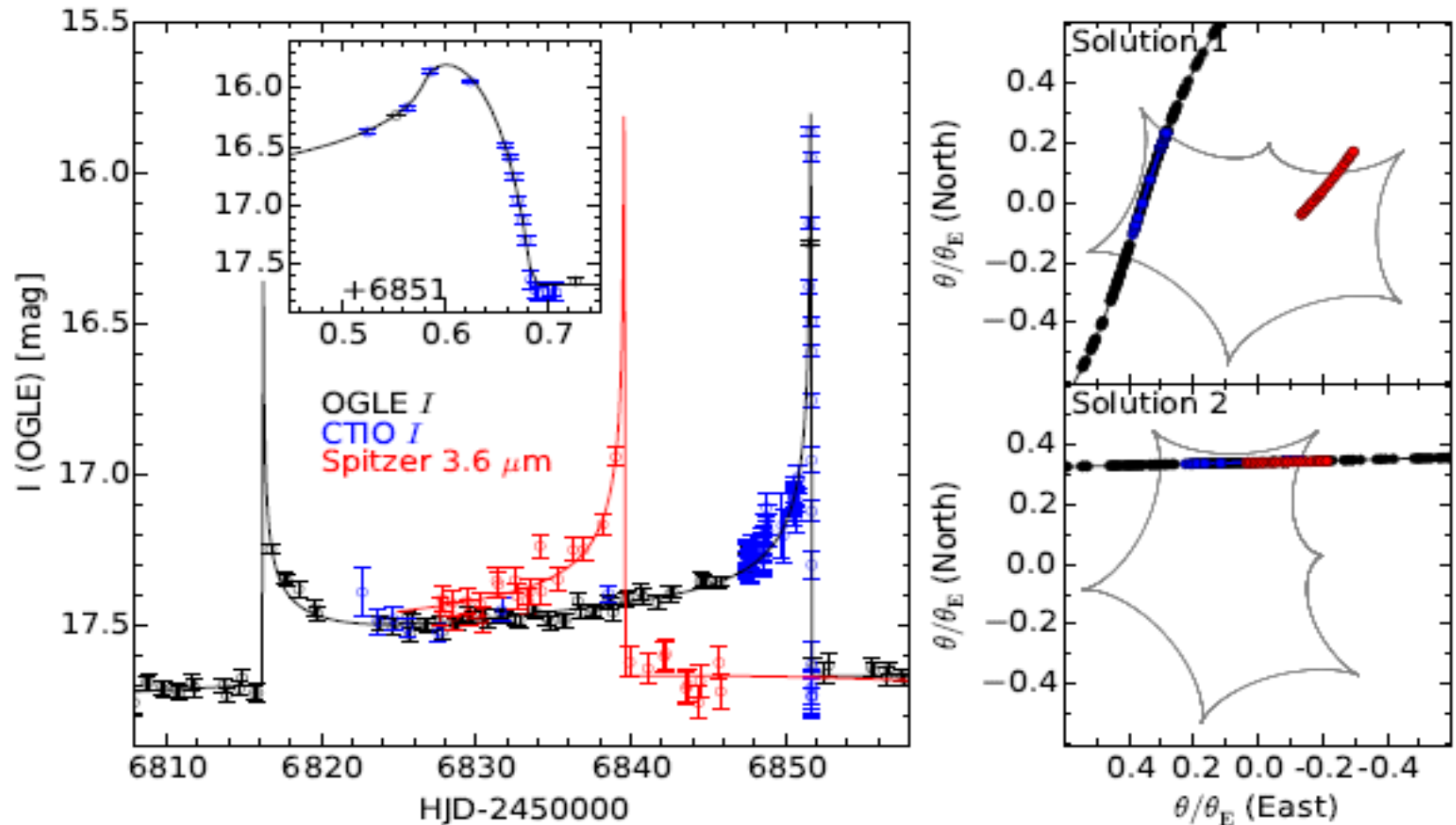

Zhu et al. 2015, ApJ, in press

Kepler (MP)³

Gould & Horne 2013, ApJ, 779, L28

Kepler (MP)³
Multi-Plexing

Gould & Horne 2013, ApJ, 779, L28

Kepler (MP)³
Multi-Plexing
for
Mass Production

Gould & Horne 2013, ApJ, 779, L28

Kepler (MP)³
Multi-Plexing
for
Mass Production
of
Microlens Parallaxes

Gould & Horne 2013, ApJ, 779, L28

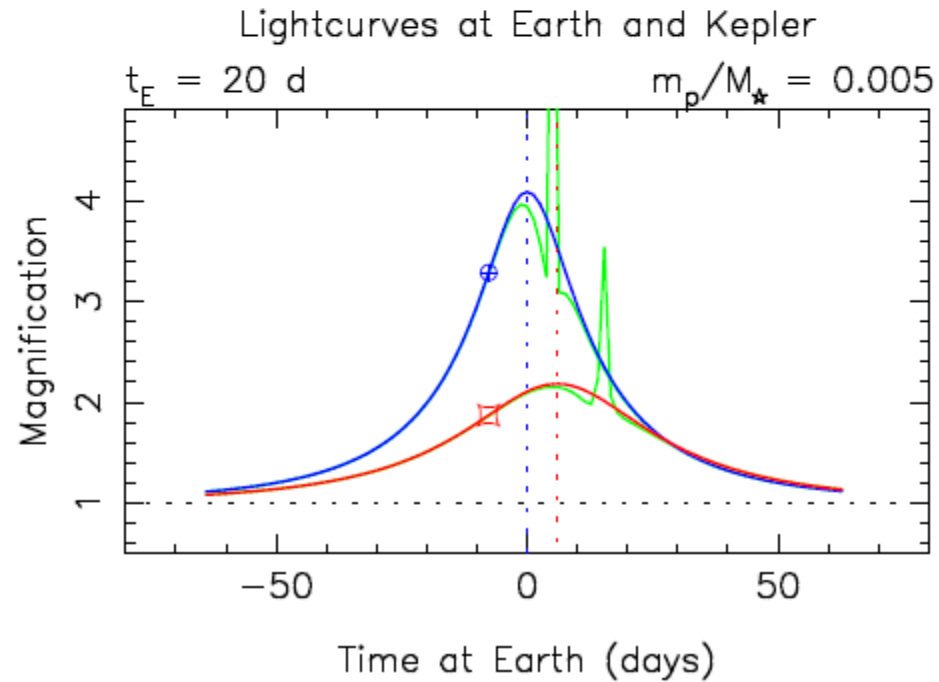
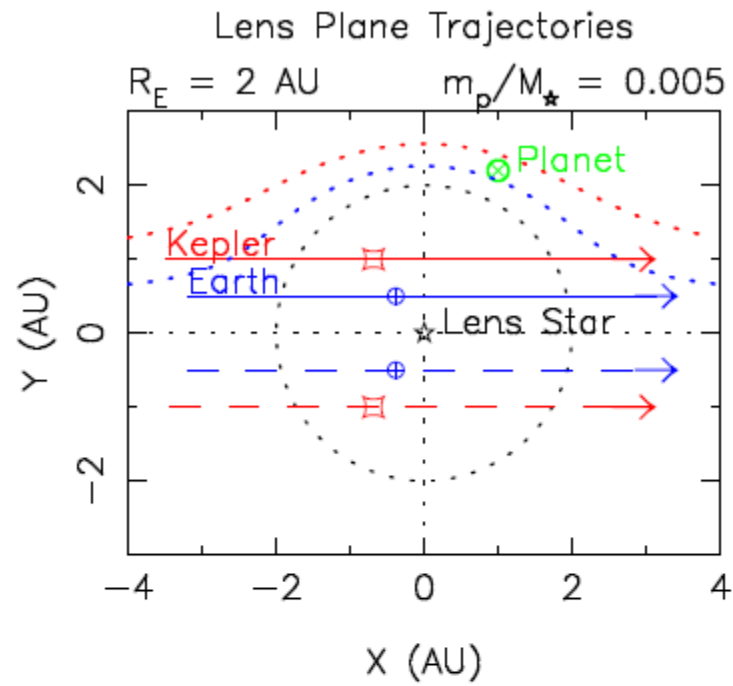

Gould & Horne 2013, ApJ, 779, L28

What we would like to do ...

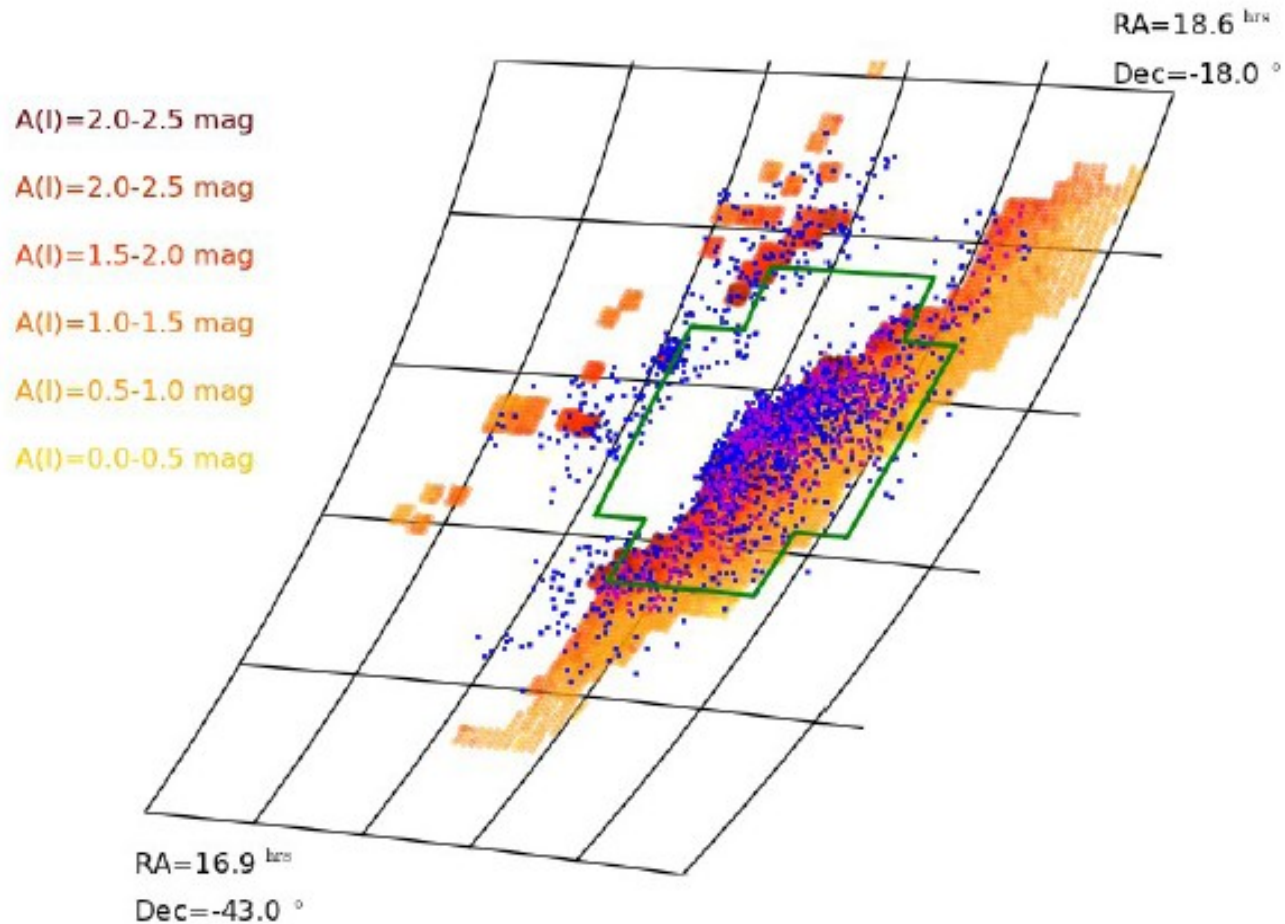

R. Street 2013, Kepler Science Meeting

... and what we can do!

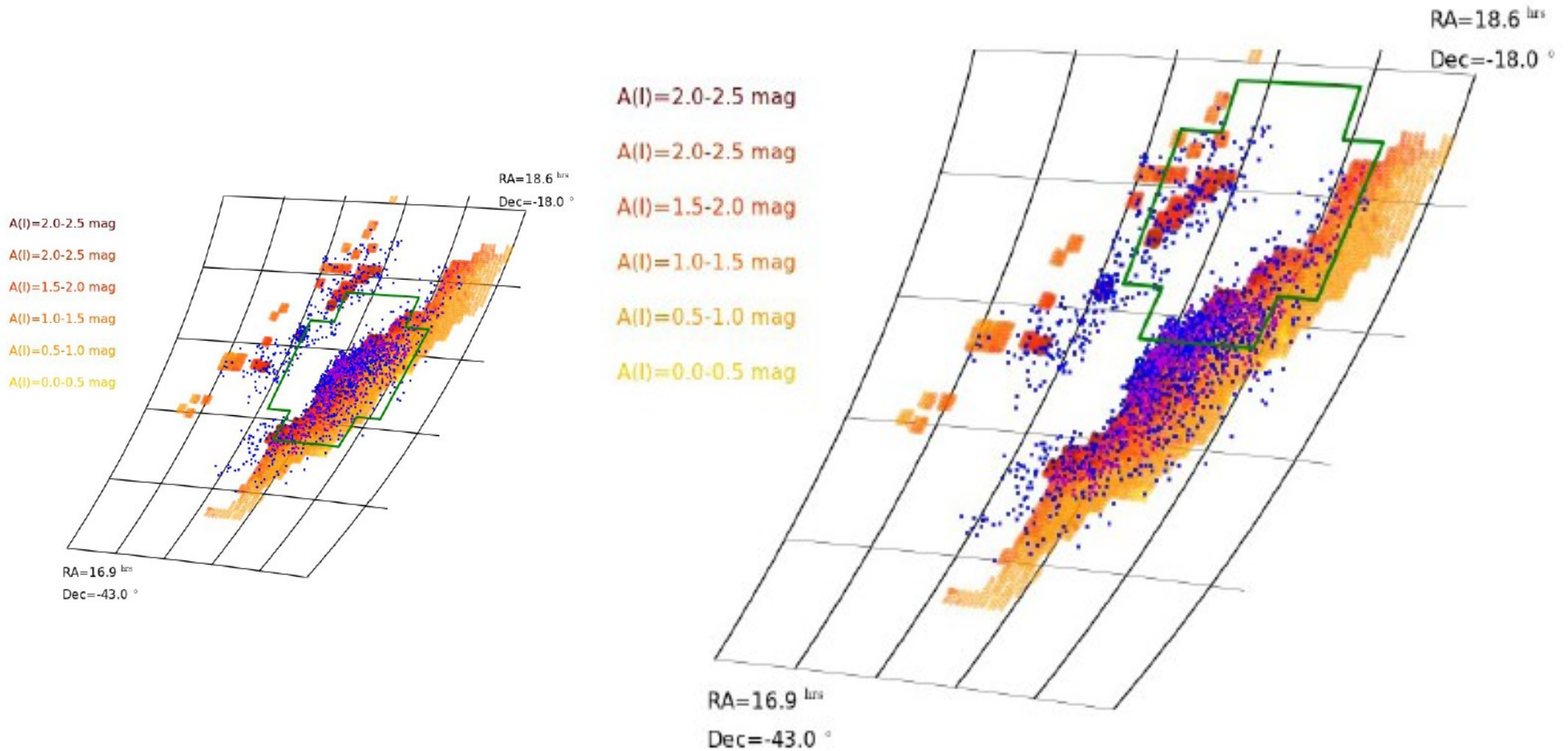

R. Street 2013, Kepler Science Meeting

Proposal: K2 Field9 5.3 Mpxl

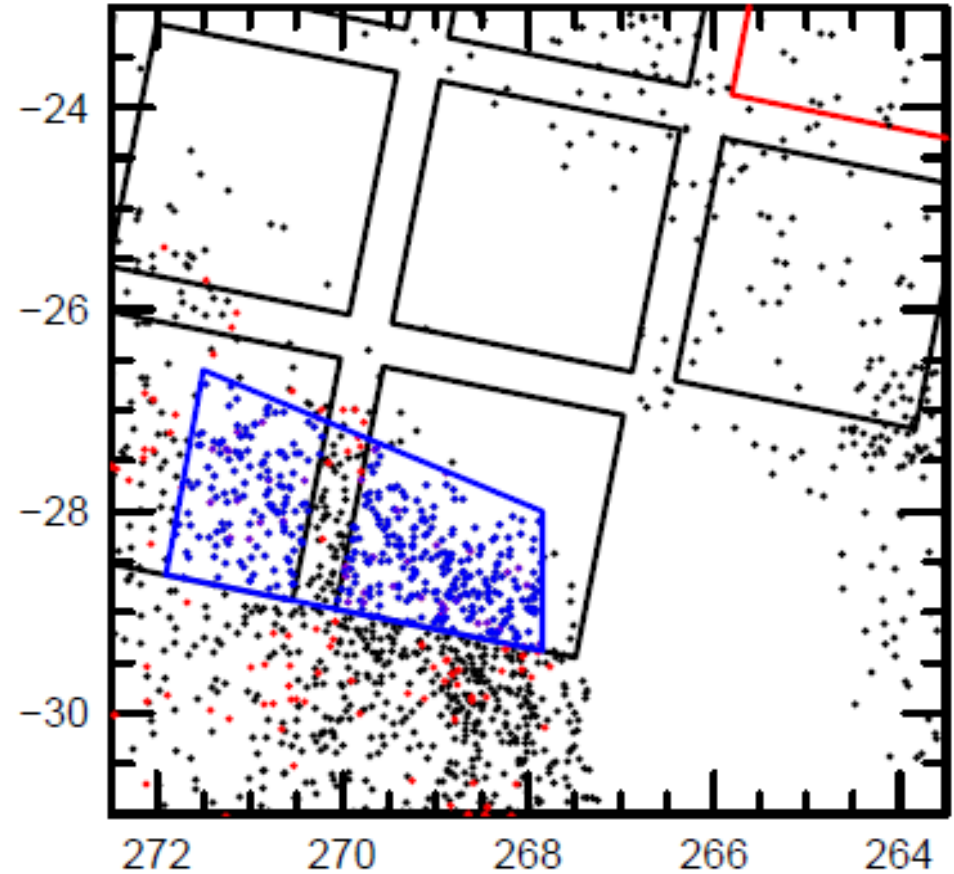
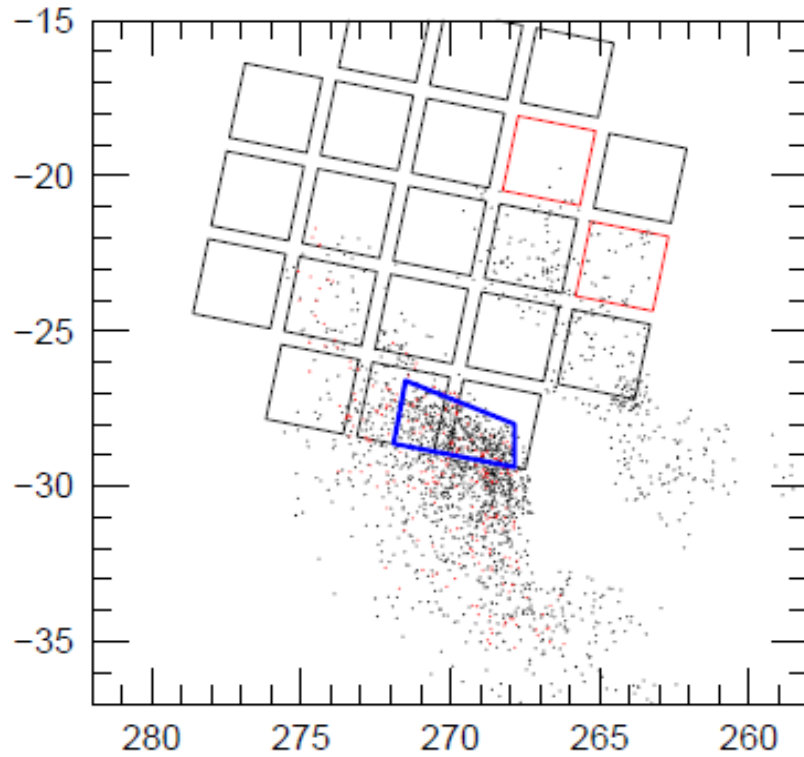

Gould, Horne, Street 2014, K2 White Paper

K2 Microlensing Science:

Short Event: If lens is a star

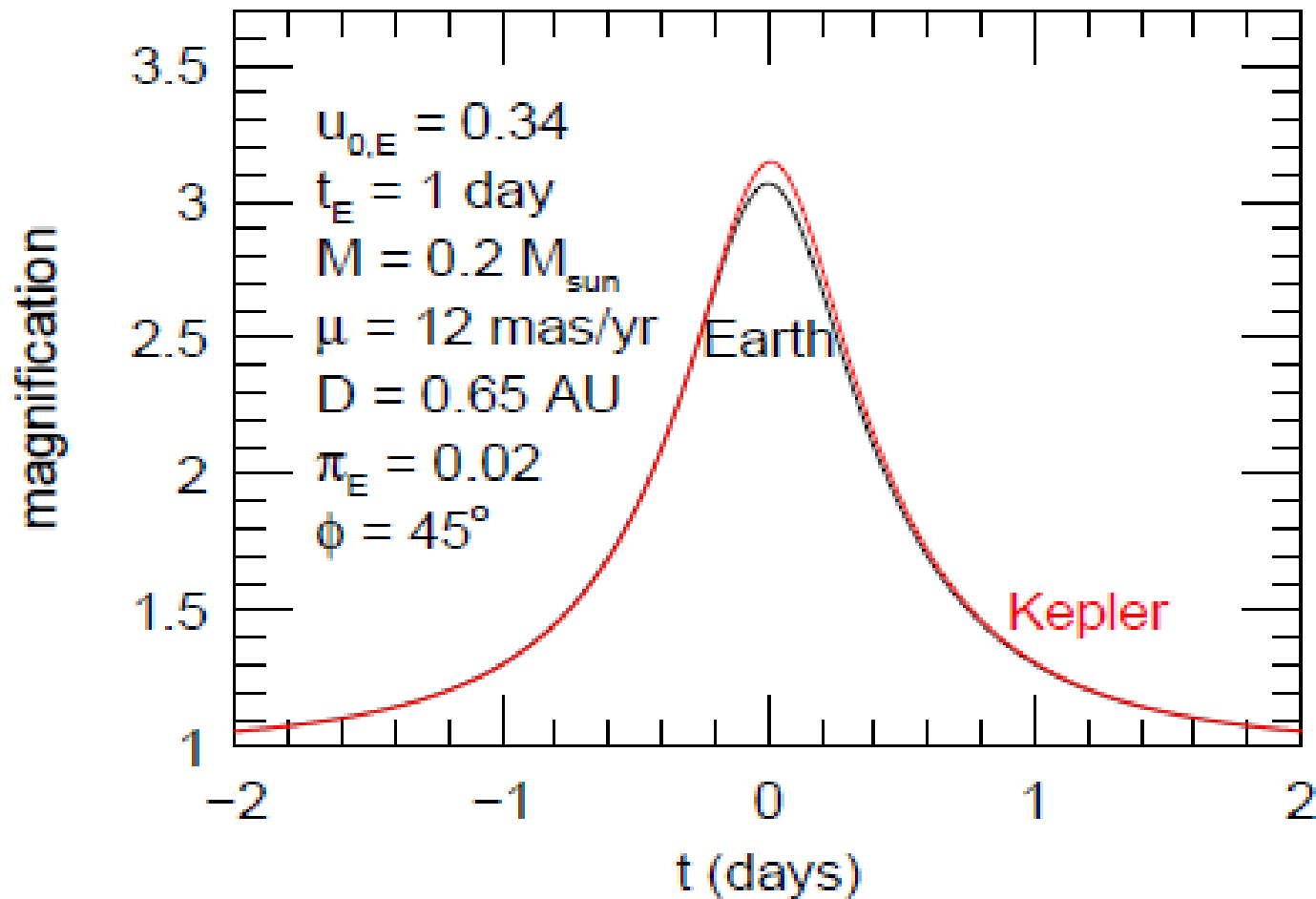

Gould, Horne, Street 2014, K2 White Paper

K2 Microlensing Science: Short Event: If lens is an FFP

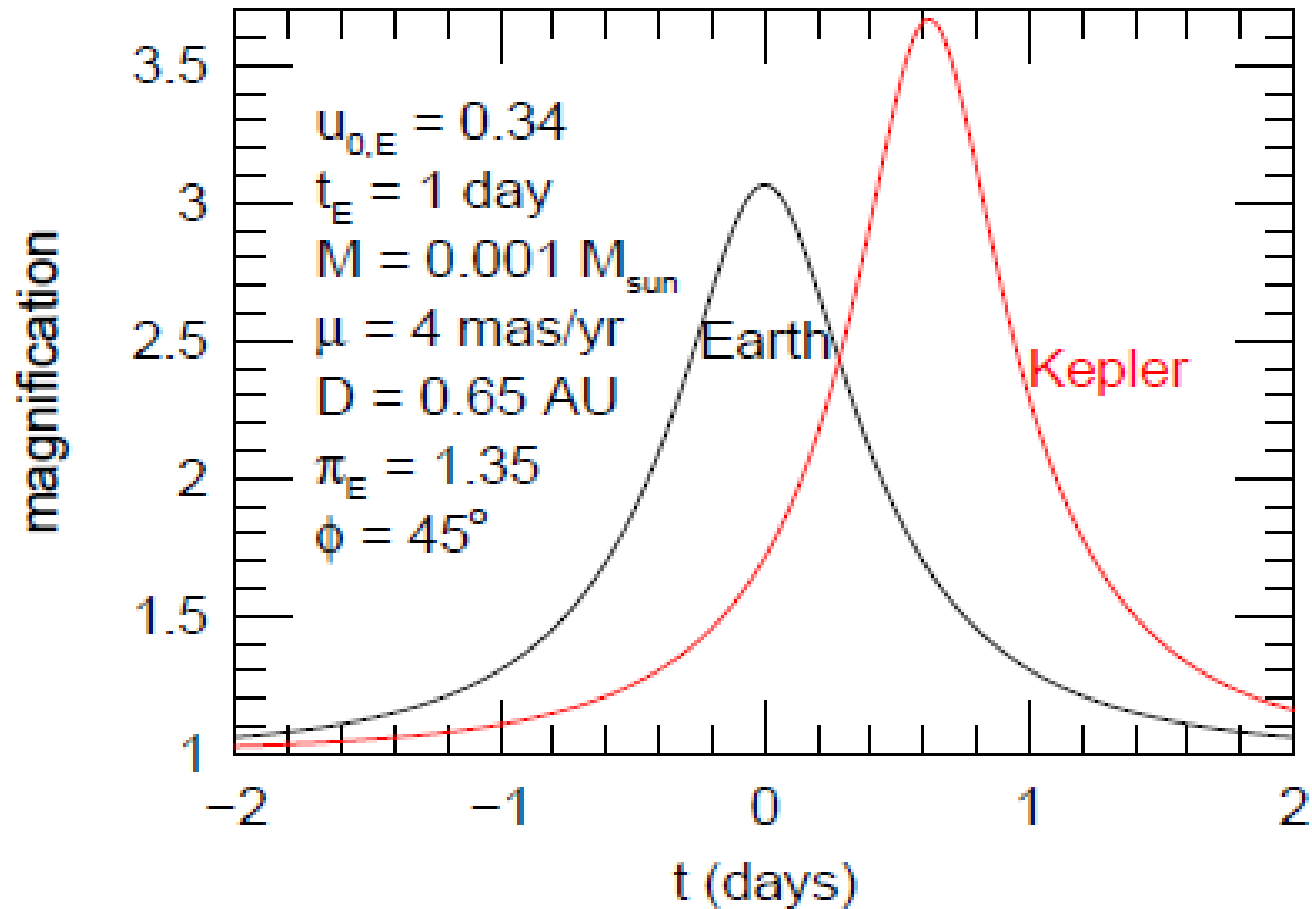

Gould, Horne, Street 2014, K2 White Paper

K2 Microlensing Science: Bound Planets: Mass and Orbit

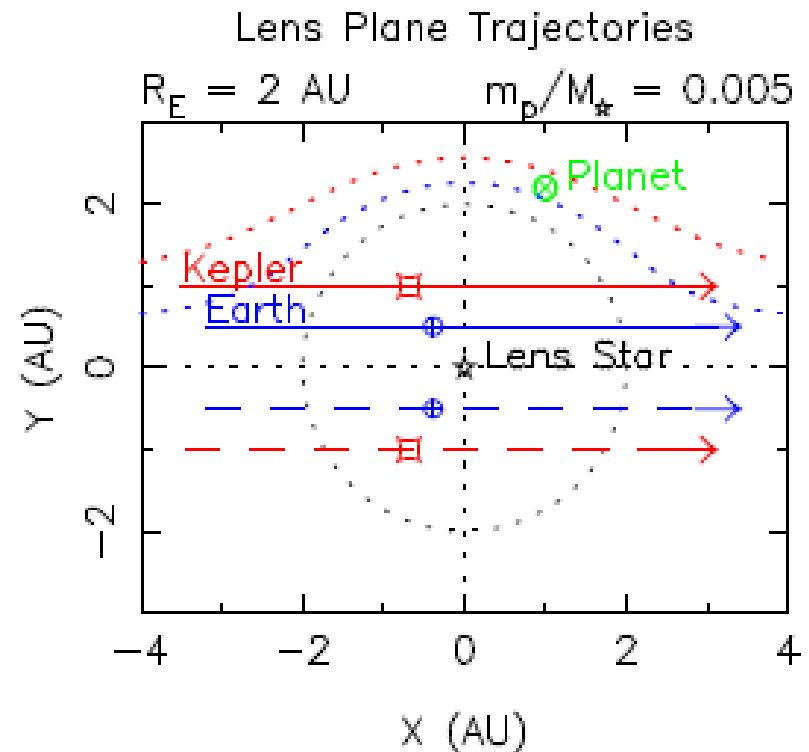
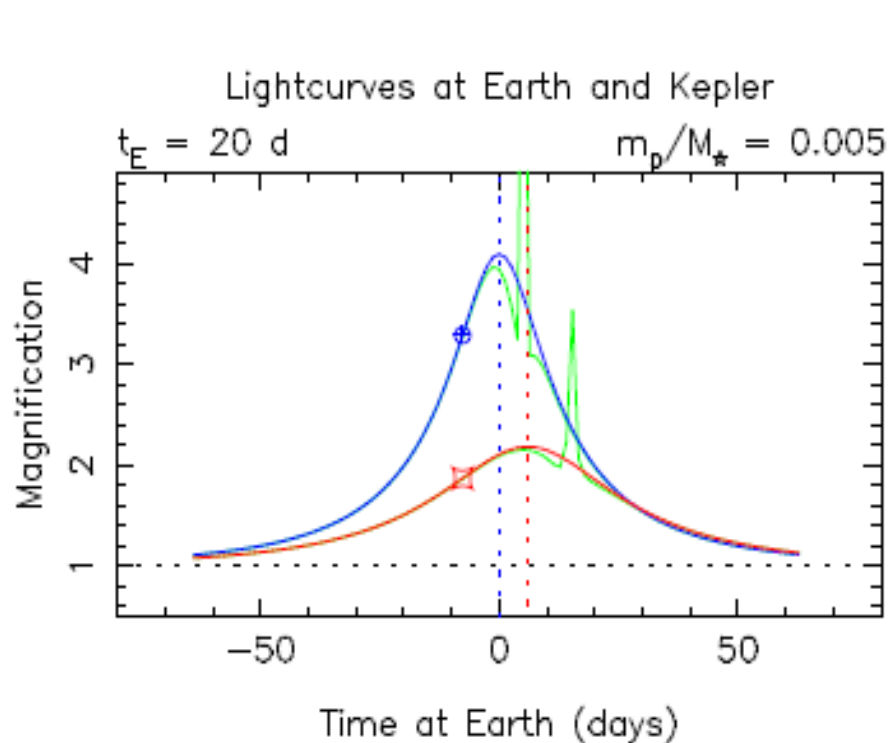

Gould, Horne, Street 2014, K2 White Paper

WFIRST

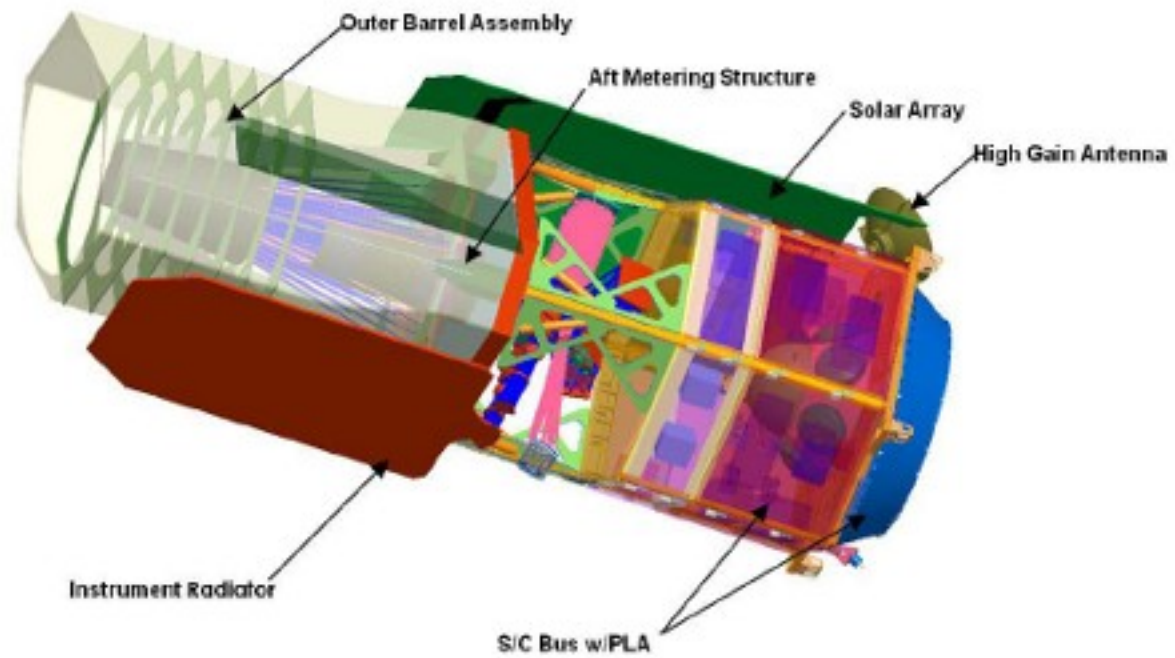

WFIRST Geosynchronous Parallaxes (Starting From Lightcurve Asymmetry)

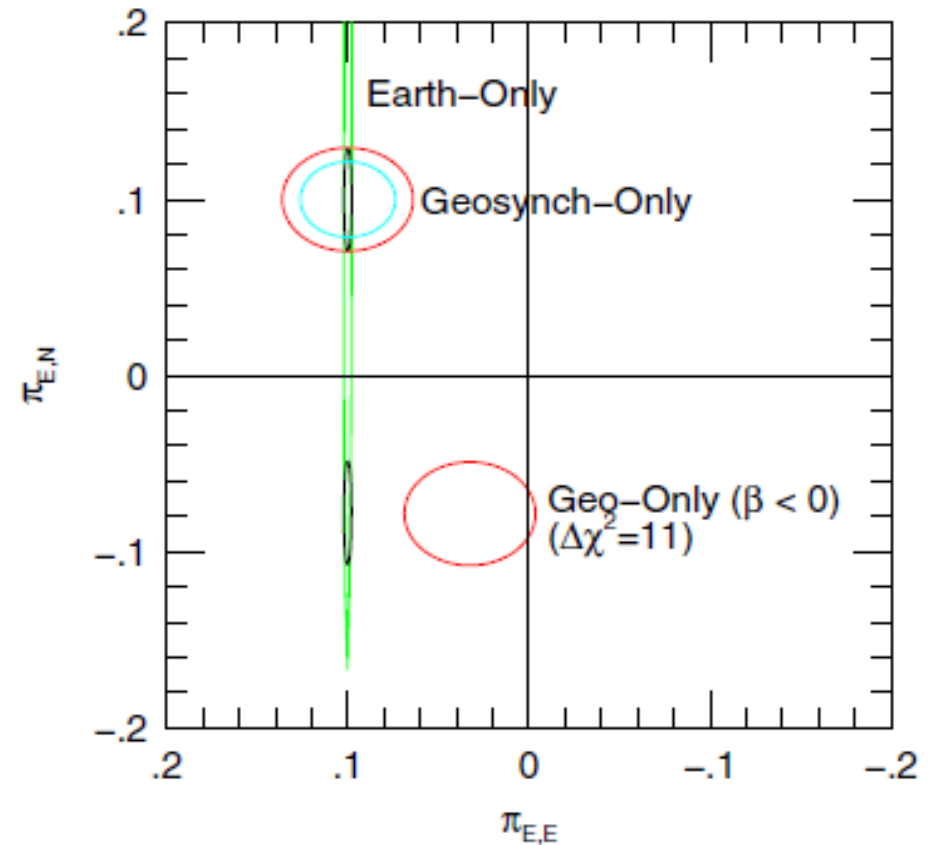
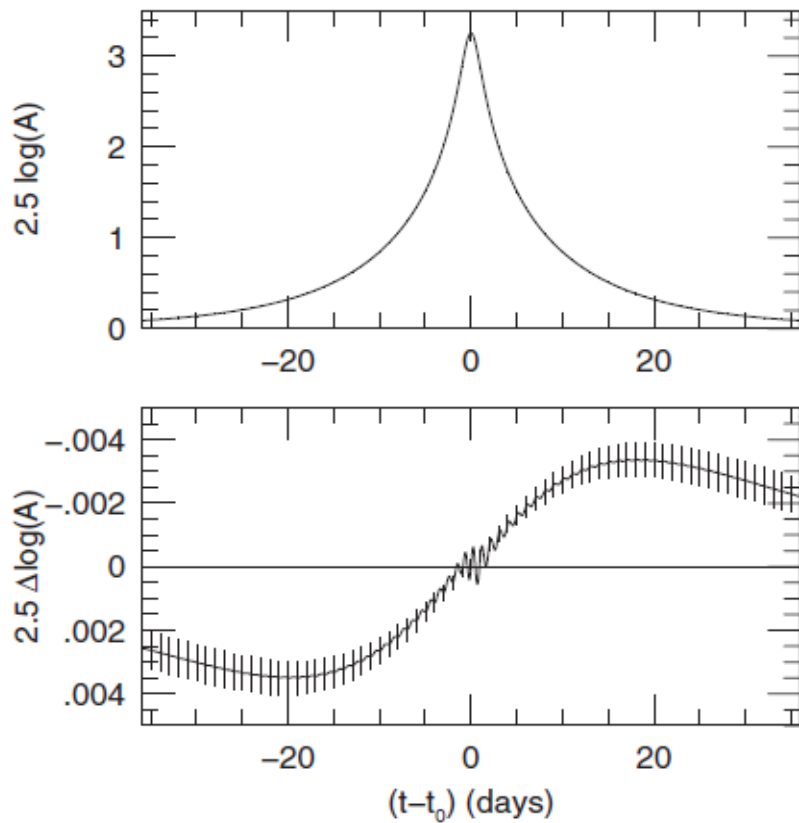

Gould 2013 ApJ, 763, L35

... or **WFIRST L2 Parallaxes**

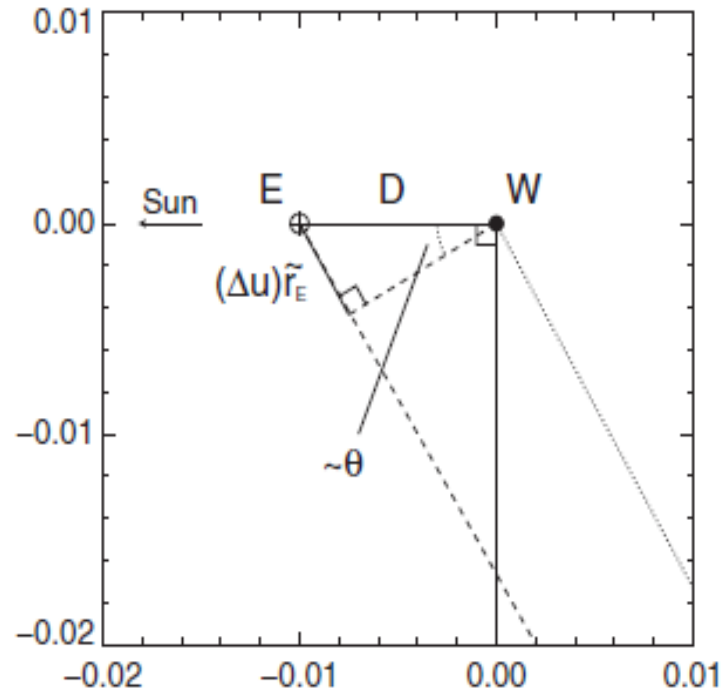
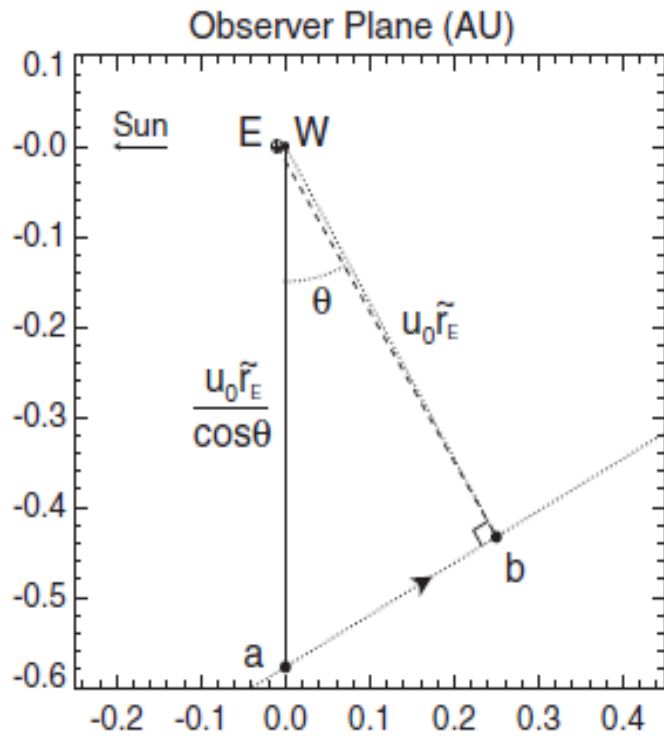

Yee 2013 ApJ, 770, L31

1-D Parallaxes Are “Common”

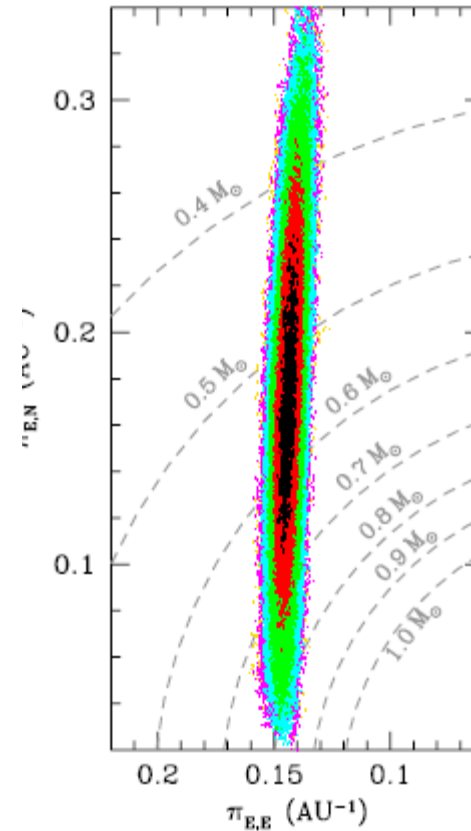
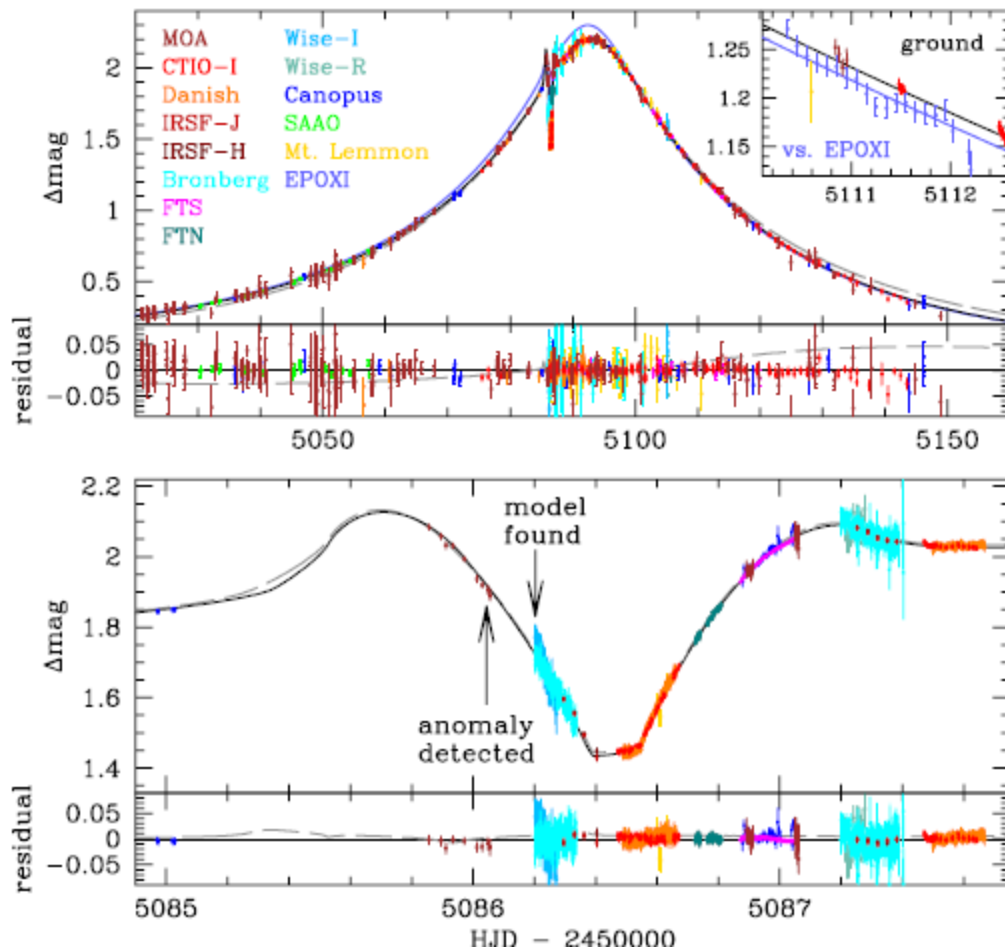

MOA-2009-BLG-266

Muraki et al. 2011, ApJ, 741, 22

$\pi_{E,\text{parallel}}$ (square peg: round hole)

Component of π_E toward Sun

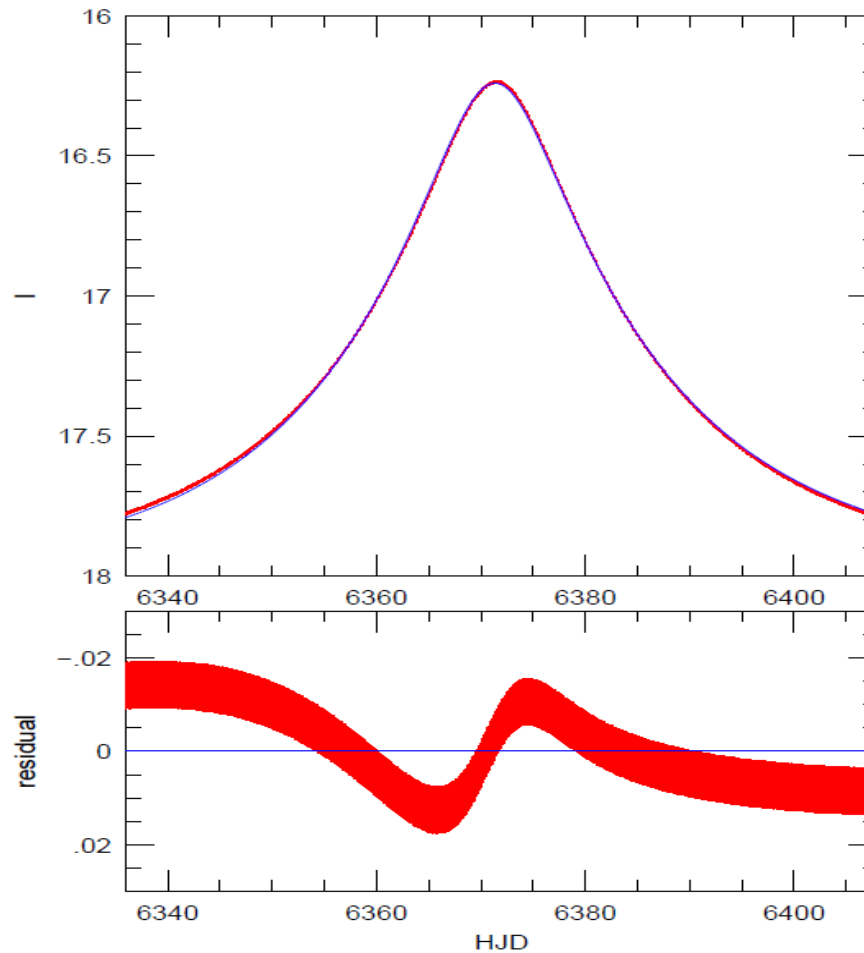

$\pi_{E, \text{perp}}$ (round peg: round hole)

Component of π_E perp to Sun

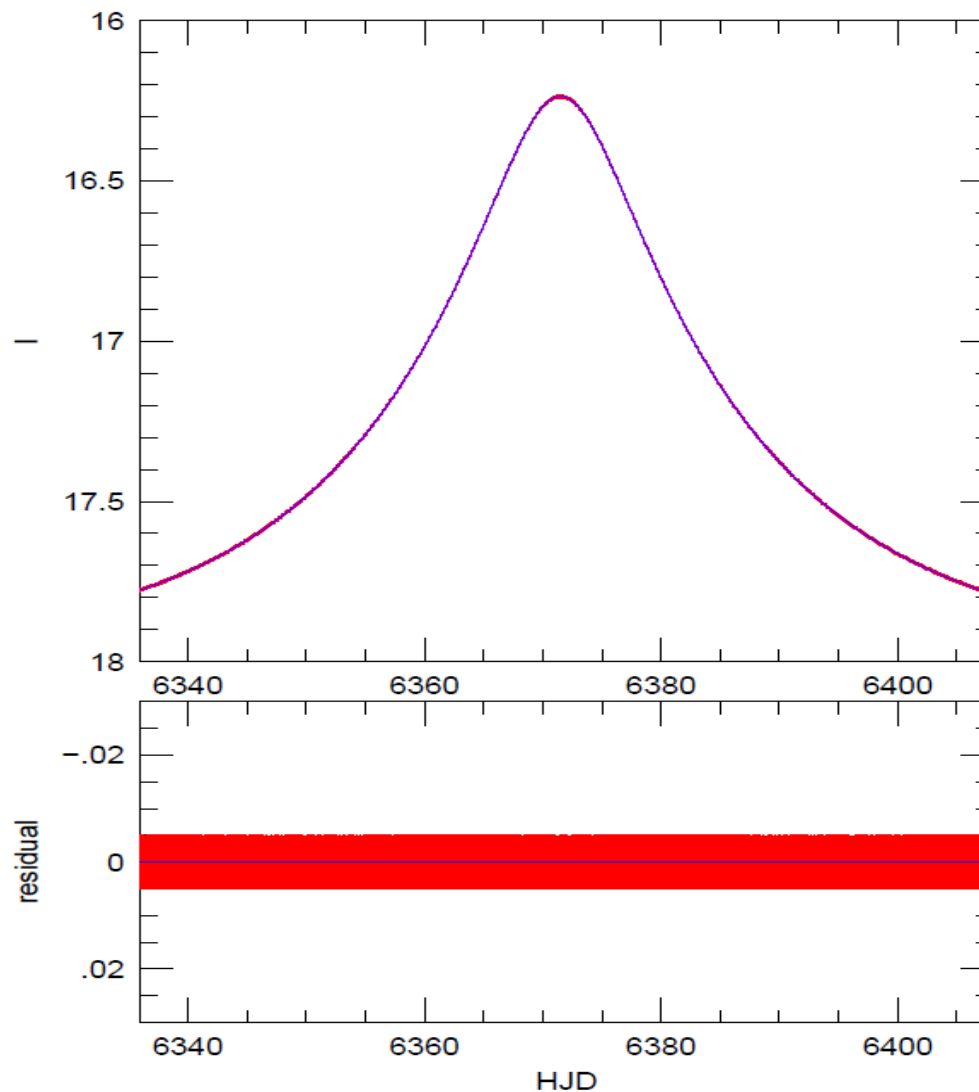

Direction of $\pi_E =$ Direction of μ ... so

- Measure $\pi_{E,\text{parallel}}$ (robust)
- Measure direction of μ (ϕ_μ)
- Infer direction of π_E ($\phi_{\pi E} = \phi_\mu$)
- Derive magnitude of $\pi_E = \pi_{E,\text{parallel}} / \cos(\phi_{\pi E})$

